



to fit

**DAF-DEUTZ-IVECO-MAN-MERCEDES
RENAULT RVI-SCANIA-VOLVO-ZF**



www.ucmparts.com



EVREN KAĞITÇILIK VE MATBAACILIK TİC. LTD. ŞTİ.
Basım Tarihi : 05.04.2013







T.C.
TÜRK PATENT ENSTİTÜSÜ

MARKA TESCİL BELGESİ

Marka No : 2009 32981 - Ticaret



**Marka Sahibi : ÜÇEM OTOMOTİV SANAYİ VE TİCARET
LİMİTED ŞİRKETİ
TÜRKİYE CUMHURİYETİ
Millet Cad. Pazartekke Sk. No:35/C Şehremini
İSTANBUL**

Emtiası : 17

Kauçuk, güta-perka, lastik, amyant (asbest), mika veya bunlardan mamul toz, levha, çubuk ve folyo halinde yarı mamul sentetik maddeler.

Mamul veya yarı mamul sentetik maddelerden yapılmış enerji izolasyonu ve emilimi amaçlı olan bu sınıfta yer alan malzemeler ve maddeler.

Lastikten, plastikten veya kauçuktan mamul bükülebilir borular, hortumlar (taşıtlar için kullanılanlar dahil), boru, kılıf ve rakorları tekstilden hortumlar, yangın hortumları, madeni olmayan boru kılıfları ve rakorları, hortum rakorları, taşıtlar için radyatör hortumları.

Markaların Korunması Hakkında 556 Sayılı Kanun Hükmünde Kararnameye göre 23/06/2009 tarihinden itibaren ON YIL müddetle 09/12/2010 tarihinde tescil edilmiştir.

Mustafa DALKIRAN
Enstitü Başkanı a.

Markalar Dairesi Başkanı

TÜRK PATENT [●] ENSTİTÜSÜ

*This is to Certify that the Management System of:
Bu belge ile Yönetim Sistemi Belgelendirilen:*

ÜÇEM OTOMOTİV SANAYİ VE TİCARET LİMİTED ŞİRKETİ

**TÜRKİBA MAH. FIRAT PLASTİK CAD.NO:45/B
BÜYÜKÇEKMECE/İSTANBUL**

*Has been assessed and found to Comply with the Requirements of:
Denetlenmiş ve aşağıdaki standartın gerekliliklerine uygunluğu görülmüştür:*

ISO 9001:2008

*The Quality Management System is applicable to:
Kalite Yönetim Sistemi:*

**MANUFACTURE OF AUTOMOTIVE GASKET ,
MANUFACTURE, SALES, MARKETING, IMPORT AND
EXPORT OF SPARE PARTS**

**OTOMOTİV CONTA İMALATI, YEDEK PARÇA İMALATI,
SATIŞI, PAZARLAMASI, İTHALAT VE İHRACATI**

**Certificate No: BCI/Q/J-INT-AV/9455
Sertifika Numarası: BCI/Q/J-INT-AV/9455**

**Date of Certification Audit: 15/03/2012
Denetim Tarihi: 15/03/2012**

**Date of Issue: 27.03.2012
Yayınlanma Tarihi: 27.03.2012**

**Date of Expiry: 14.03.2015
Son Geçerlilik Tarihi:14.03.2015**

**1st Surveillance Audit : February 2013
1. Gözetim Denetim Tarihi : Şubat 2013
2nd Surveillance Audit : February 2014
2. Gözetim Denetim Tarihi : Şubat 2014**

M D



CATALOGUE INDEX

to FIT

Daf.....	1-14
Deutz.....	15-57
Iveco.....	58-71
Man.....	72-98
Mercedes.....	99-136
Renault RVI.....	137-142
Scania.....	143-167
Volvo.....	168-205
ZF.....	206-208
Compressor Gasket.....	209-280



to fit- DAF



www.eurogasket.com.tr

To fit DAF

FULL SET GASKET

Engine Model / Description	Eurogasket Part Number	OEM Part Number	Product Picture
DAF 1160 – 2300 - 2800 Full Set Gasket	992 370 + 0428 433 + 0710 455	118 730 + 0682 677 + 0390 655	
DAF 95 WS DAF F80 DAF F95 Full Set Gasket	428 420		
DAF 85 CF DAF 95 XF Full Set Gasket	0427 773		
DAF 615 Full Set Gasket Ø104 6 Cyl.	0428 443 + 349 597 + 428 425	0682 667 + 761 513 + 682 685	
DAF 825 Full Set Gasket	427 907 + 9771 442 + 0428 441	683 103 + 1339 668 + 0682 669	

Disclaimer: OEM numbers are for reference only and do not imply that they are originals parts.



www.eurogasket.com.tr

To fit DAF

FULL SET GASKET

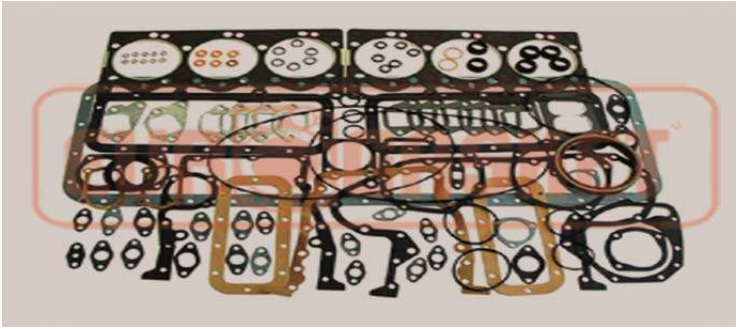
Engine Model / Description	Eurogasket Part Number	OEM Part Number	Product Picture
DAF DA475-DD475-DD575 F900-1100-1300-1400-1600 Full Set Gasket	0840 706		
DAF RF865-RS865 F75 – CF85 Full Set Gasket	0428 428		

Disclaimer: OEM numbers are for reference only and do not imply that they are originals parts.



www.eurogasket.com.tr

To fit DAF

CONVERSION SET

Engine Model / Description	Eurogasket Part Number	OEM Part Number	Product Picture
DAF DH 825 DAF DHB 825 Conversion Set	427 907	683 103	
DAF DK 1160 DAF DKA 1160 DAF F2400-2600-2800 Conversion Set	992 370	118 730	
DAF F95 DAF WS 225-242-259 268-282 WS 1160 Conversion Set	429 439 427 904	681 671 683 106	
DAF CF 85 - 95 DAF XE 250-280-315- 355-390 DAF 95 XF Conversion Set	0 427 919	0 683 191 Elring No: 498 930	
DAF DA475 – DD475 – DD575 F900-1100-1300-1400- 1600 DF615-DT615-DTD615 F1100-1200-1300-1400- 1500-1600-1800 Conversion Set	428 425	682 685	

Disclaimer: OEM numbers are for reference only and do not imply that they are originals parts.



www.eurogasket.com.tr

To fit DAF

HEAD SET GASKET

Engine Model / Description	Eurogasket Part Number	OEM Part Number	Product Picture
DAF 1160 – 2300 - 2800 Head Set Gasket	428 433	0 682 677	
DAF DH 825 DHB 825 Head Set Gasket	0 428 441	0 682 669	
DAF 85 - 95 Head Set Gasket	0 428 420	0 682 680 Elring No: 917 208	
DAF 620 Head Set Gasket	0 4282 25	0 682 885	
DAF 615 Head Set Gasket	0428 443	0682 667 Elring No: 759 512	

Disclaimer: OEM numbers are for reference only and do not imply that they are originals parts.



www.eurogasket.com.tr

To fit DAF

HEAD SET GASKET

Engine Model / Description	Eurogasket Part Number	OEM Part Number	Product Picture
DAF CF 85XF – 95XF DAF XE 250-280-315 355-390 Head Set Gasket	0 427 578	0 683 532 Etring No: 497 940	
DAF DA475-DD475 DD575 F900-1100-1300-1400- 1600 Head Set Gasket	840 706	260 304	
DAF RF865 – RJ865 F75 – CF85 Head Set Gasket	428 428	682 682	
DAF DHS825-DHT825 F2100-2300-2500 Head Set Gasket	428 437	682 673	
DAF 95XF Head Set Gasket	427 773	683 337	

Disclaimer: OEM numbers are for reference only and do not imply that they are originals parts.



www.eurogasket.com.tr

To fit DAF

CYLINDER HEAD GASKET

Engine Model / Description	Eurogasket Part Number	OEM Part Number	Product Picture
DAF 1160 – 2300 - 2800 Cylinder Head Gasket	0 710 455	0 390 655	
DAF 825 Cylinder Head Gasket (Without Ring)	0016 309	0094 701 Elring No: 759 709	
DAF 825 Cylinder Head Gasket (With Ring)	9 771 442	1 339 668 Elring No: 497 270	
DAF 95 DAF 95 XF Cylinder Head Gasket	9 780 738	1 320 372 Elring No: 760 082	
DAF 620 Cylinder Head Gasket (With Ring) Ø 116	9 827 981	1 283 129	

Disclaimer: OEM numbers are for reference only and do not imply that they are originals parts.



www.eurogasket.com.tr

To fit DAF

CYLINDER HEAD GASKET

Engine Model / Description	Eurogasket Part Number	OEM Part Number	Product Picture
DAF 615 Cylinder Head Gasket Ø 107	349 597	761 513	
DAF DD575 F900 – 1100 - 1500 1600 - 1800 Cylinder Head Gasket	9 867 739	1 243 371	

Disclaimer: OEM numbers are for reference only and do not imply that they are originals parts.



www.eurogasket.com.tr

To fit DAF

OIL PAN GASKET

Engine Model / Description	Eurogasket Part Number	OEM Part Number	Product Picture
DAF 825 F1800-2000-2100-2200- 2300-2500-2700 Oil Pan Gasket	988 4245 734 539	122 6865 376 571 Elring No: 759 750	
DAF 85 DAF 95 Oil Pan Gasket	0 012 591	0 098 519 Elring No: 489 090	
DAF 1160 – 2300 - 2800 Oil Pan Gasket	0 357 487	0 753 623 Elring No: 759 962	
DAF 475-515-615 F900-1100-1300-1500- 1600-1800 Oil Pan Gasket	356 967	754 143	
DAF 95XF 530 Oil Pan Gasket	965 2309 979 5729	145 8701 131 5381 Elring No: 375 920	







Disclaimer: OEM numbers are for reference only and do not imply that they are originals parts.



www.eurogasket.com.tr

To fit DAF

VALVE COVER GASKET

Product Details		Product Picture	
<p>DAF 825 Valve Cover Gasket</p> <p>OEM No: 0 240 564</p> <p>Eurogasket No: 0 860 546</p>		<p>DAF 95 XF Valve Cover Gasket (With Siliconed)</p> <p>OEM No: 1 361 567</p> <p>Eurogasket No: 9 769 581</p> <p>Elring No: 497 300</p>	
<p>DAF 95 XF Valve Cover Gasket</p> <p>OEM No: 1 361 567</p> <p>Eurogasket No: 9 749 543</p>		<p>DAF 95 XF Valve Cover Gasket</p> <p>OEM No: 1 341 529</p> <p>Eurogasket No: 9 769 581</p> <p>Elring No: 116 130</p>	
<p>DAF 95 XF Valve Cover Gasket</p> <p>OEM No: 1 300 061</p> <p>Eurogasket No: 9 700 049</p> <p>Elring No: 497 310</p>		<p>DAF 1160 – 2300 - 2800 Valve Cover Gasket</p> <p>OEM No: 0 241 103</p> <p>Eurogasket No: 0 869 907</p>	
<p>DAF 1160 – 2300 - 2800 Valve Cover Gasket MVQ</p> <p>OEM No: 0 241 144</p> <p>Eurogasket No: 0 869 966</p> <p>Elring No: 759 988</p>			

Disclaimer: OEM numbers are for reference only and do not imply that they are originals parts.



www.eurogasket.com.tr

To fit DAF

INTAKE MANIFOLD GASKET

Product Details		Product Picture		Product Details		Product Picture					
<p>DAF 85 DAF 95 Intake Manifold Gasket</p> <p>OEM No: 1 336 089</p> <p>Eurogasket No: 9 774 021</p>		<p>DAF 85 DAF 95 Intake Manifold Gasket</p> <p>OEM No: 1 336 090</p> <p>Eurogasket No: 9 774 010</p>		<p>DAF 1160 Intake Manifold Gasket</p> <p>OEM No: 0 241 374</p> <p>Eurogasket No: 0 869 736</p>		<p>DAF 2600 – 2800 – 3300 - 3600 Intake Manifold Gasket</p> <p>OEM No: 0 241 297</p> <p>Eurogasket No: 0 869 813</p>					

Disclaimer: OEM numbers are for reference only and do not imply that they are originals parts.



www.eurogasket.com.tr

To fit DAF

EXHAUST MANIFOLD GASKET

Product Details		Product Picture	
<p>DAF 85-95 Exhaust Manifold Gasket</p> <p>OEM No: 0 269 548</p> <p>Eurogasket No: 0 841 562</p> <p>Elring No: 493 490</p>		<p>DAF 95 XF Exhaust Manifold Gasket</p> <p>OEM No: 1 676 984</p> <p>Eurogasket No: 9 434 126</p>	
<p>DAF F1600 Exhaust Manifold Gasket</p> <p>OEM No: 0 242 216</p> <p>Eurogasket No: 0 868 894</p>		<p>DAF 1160 - 2800 Exhaust Manifold Gasket</p> <p>OEM No: 0 227 103</p> <p>Eurogasket No: 0 883 907</p> <p>Elring No: 759 929</p>	
<p>DAF 2300-2800-3300-3600 Exhaust Manifold Gasket</p> <p>OEM No: 0 241 374</p> <p>Eurogasket No: 0 869 736</p>		<p>DAF 2300-2800-3300-3600 Exhaust Manifold Gasket</p> <p>OEM No: 0 241 297</p> <p>Eurogasket No: 0 869 813</p>	

Disclaimer: OEM numbers are for reference only and do not imply that they are originals parts.



www.eurogasket.com.tr

To fit DAF

TURBO GASKET

Product Details		Product Picture	
<p>DAF 1160 – 2300 – 2800 DAF WS 95 – 95 XF Turbo Gasket</p> <p>OEM No: 0 94196</p> <p>Eurogasket No: 0 16914</p>		<p>DAF 1160 – 2300 – 2800 DAF WS 95 – 95 XF Turbo Gasket</p> <p>OEM No: 1 302 930</p> <p>Eurogasket No: 9 708 170</p> <p>Elring No: 314 812</p>	
<p>DAF F1600 Turbo Gasket</p> <p>OEM No: 233 473</p> <p>Eurogasket No: 877 637</p>			

Disclaimer: OEM numbers are for reference only and do not imply that they are originals parts.



www.eurogasket.com.tr

SEALS – To Fit DAF



OEM Part Number	DPH Part Number	Eling Part Number	Corteco Part Number	Application	Dimensions
0010 588	35192	043737	07013486	Crankshaft	80 x 95 x 8 NBR
0015 484	81336		12013388	Front Axle	85 x 110 x 13/9,5 NBR
0015 485	81336		12013388	Front Axle	85 x 110 x 13/9,5 NBR
0015 599	19880				110 x 130 x 13 NBR
0066 322	116002		01020066	Crankshaft	26 x 34 x 4,5/7 NBR
0077 479	110004		01016687	Differential	85 x 125 x 12 FPM
0110 466	4545	033472	12011307	Gearbox	48 x 75 x 8 FPM
0110 732	37867		12011351		17 x 28 x 7 NBR
0119 198	68544	038326	12010859	Crankshaft	25 x 47 x 10 NBR
0119 199	113776	201006	12010879	Crankshaft	30 x 40 x 7 NBR
0119 468	17448	050300	12011112	Crankshaft	17 x 28 x 7 NBR
0140 335	4378	038083	12014616	Gear Box	25 x 35 x 7 NBR
0140 783	82528	033464	12013757	Gear Box	85 x 105 x 10 FPM
0140 784	47944	348856	120114736		70 x 90 x 10 FPM
0190 069	94834		19031938	Wheel Hub	114 x 142/170 x 14/27 NBR
0213 966	94735	344400		Water Pump	42 x 56 x 7 NBR
0240 443	51252			Crankshaft	125 x 150 x 15 FPM
0240 631	82341	760544		Crankshaft	70 x 90 x 12 ACM
0259 939	114423		12015609	Crankshaft	160 x 185 x 14 ACM
0259 940	114423		12015609	Crankshaft	160 x 185 x 14 ACM
0266 146	51252			Crankshaft	125 x 150 x 15 FPM
0281 986	82347		12015531	Crankshaft	100 x 124 x 13 FPM
0292 766	81798		01015140	Axle	125 x 160 x 17 FPM
0299 521	111748		01029683	Crankshaft	65 x 90 x 10 FPM
0325 321	18646		12011019	Crankshaft	72 x 100 x 10 NBR
0376 992	114401		01017057	Differential	85 x 140 x 15/16,5 FPM/NBR
0500 162	114314		01032389	Wheel Hub	120 x 142/150 x 37 NBR
0538 953	114399			Differential	85 x 110 x 12/16 FPM
0558 114	82345		12015530	Crankshaft	154 x 180 x 15 FPM
0572 372	4306			Front/Rear Axle	80 x 100 x 10 NBR
0578 507	32425		12011359	Gear Box	85 x 105 x 13 NBR
0585 373	95872	033480	12011341	Gear Box	85 x 105 x 12/10 NBR
0585 910	113749		12013365	Gear Box	60 x 74 x 10/8 FPM
0586 697	81637	040991	12011331	Gear Box	48 x 65 x 10 NBR
0609 458	4545	033472	12011307	Gear Box	48 x 75 x 8 FPM
0609 475	82528	033464	12013757	Gear Box	85 x 105 x 10 FPM
0647 330	113945		12015029	Wheel Hub	100 x 135 x 13 NBR

Disclaimer: OEM numbers are for reference only and do not imply that they are originals parts.



www.eurogasket.com.tr

SEALS – To Fit DAF



OEM Part Number	DPH Part Number	Etring Part Number	Corteco Part Number	Application	Dimensions
0662 004	17829		12000157	Wheel Hub	32 x 45 x 7 NBR
0678 157	81799		01015143	Axle	120 x 160 x 17,50 NBR
0682 961	82345		12015530	Crankshaft	154 x 180 x 15 FPM
0682 962	51252	493360		Crankshaft	125 x 150 x 15 FPM
0691 048	114367		01030337	Crankshaft	63,50 x 102,50 x 6,6/14,8 FPM
0692 009	116145			Wheel Hub	25,45 x 44,43 x 5,1/6,1 MVQ
0693 402	47988		12011306	Gear Box	48 x 69 x 10 FPM
0693 928	82528	033464	12013757	Gear Box	85 x 105 x 10 FPM
0696 084	96979		12012235	Gear Box	95,30 x 114,29 x 11,88 FPM
0893 004	114416		01019705	Gear Box	110 x 140 x 15,5/20 FPM
1 602 361	19863		12011209	Crankshaft	100 x 120 x 12 NBR
1 684 105	120079			Crankshaft	134 x 161 x 16 NBR
1 684 106	120081			Crankshaft	166 x 191 x 16 NBR
1226 734	114379	763144	12014700	Crankshaft	70 x 90 x 10 FPM
1236 238	114809		01027785	Crankshaft	26 x 35 x 11 NBR
1238 034	81800		12015758	Wheel Hub	100 x 140 x 15/20,5 NBR
1242 697	9868 413				105 x 150 x 12 FPM
1275 082	51252	493360		Crankshaft	125 x 150 x 15 FPM
1275 083	82345		12015530	Crankshaft	154 x 180 x 15 FPM
1275 084	95198			Crankshaft	100 x 124 x 12 FPM
1278 420	113947		01015141	Wheel Hub	100 x 140 x 15,5/20 FPM
1278 421	114316		01015529	Crankshaft	90 x 140 x 15,5/20 FPM
1278 423	113948		01015348	Crankshaft	100 x 150 x 15/20 FPM
1283 668	111388		01017058	Differential	78 x 115 x 13/17 FPM
1287 102	111387		01027965	Differential	85 x 140 x 13/17 FPM
1287 103	114397		01029753	Differential	80 x 120 x 13/17 FPM
1334 961	112832		01026332	ABS	100 x 140/166 x 16/22 NBR
1335 063	109670		01026336	ABS	125 x 160/190 x 18/20 FPM/PA
1340 320	115386	017590	20029771	Crankshaft	154 x 180 x 12 AEM/PTFE
1340 321	114410	493330	15027586	Crankshaft	100 x 124 x 12 PTFE/ACM
1370 127	115386	175990	20029771	Crankshaft	154 x 180 x 12 PTFE/AEM
140 619	84534			Front Axle	120,65 x 146,05 x 12,70 NBR
1400 080	114447		01034436	Wheel Hub	82 x 105 x 10 NBR
1404 690	113051		19034570		90 x 130 x 17 NBR
1700 329	117760		19034569	Wheel Hub	100 x 130 x 17 NBR
1739 947	111387			Differential	85 x 140 x 13/17 FPM
3104 047	70214		12010923	Crankshaft	38 x 50 x 7 NBR

Disclaimer: OEM numbers are for reference only and do not imply that they are originals parts.



to fit- DEUTZ



www.eurogasket.com.tr

To fit DEUTZ

FULL SET GASKET

Engine Model / Description	Eurogasket Part Number	OEM Part Number	Product Picture
DEUTZ F6L 413 V Full Set Gasket	0819 9589	0291 1521	
DEUTZ F8L 413 V Full Set Gasket	0818 2278	0292 8832	
DEUTZ F10L 413 V Full Set Gasket	0819 9583	0291 1527	
DEUTZ F12L 413 V Full Set Gasket	0819 9582	0291 1528	
DEUTZ F6L 413 F Full Set Gasket	0818 2299	0292 8811	

Disclaimer: OEM numbers are for reference only and do not imply that they are originals parts.



www.eurogasket.com.tr

To fit DEUTZ

FULL SET GASKET

Engine Model / Description	Eurogasket Part Number	OEM Part Number	Product Picture
DEUTZ F8L 413 F / 513 Full Set Gasket Cyl. 125 mm	0818 2201	0292 8809	
DEUTZ F10L 413 F/ 513 Full Set Gasket Cyl. 125 mm	0818 2297	0292 8813	
DEUTZ F10L 413 FW Full Set Gasket	0818 2280	0292 8820	
DEUTZ F4L 413 R Full Set Gasket	0863 7501	0247 3509	
DEUTZ F5L 413 R Full Set Gasket	0819 9587	0291 1523	

Disclaimer: OEM numbers are for reference only and do not imply that they are originals parts.



www.eurogasket.com.tr

To fit DEUTZ

FULL SET GASKET

Engine Model / Description	Eurogasket Part Number	OEM Part Number	Product Picture
DEUTZ F6L 413 R Full Set Gasket	0819 9586	0291 1524	
DEUTZ F4L 413 FR Full Set Gasket	0863 2801	0247 8209	
DEUTZ F5L 413 FR Full Set Gasket	0818 2288	0292 8822	
DEUTZ F6L 413 FR Full Set Gasket	0818 2287	0292 8823	
DEUTZ BF12L 413 F Full Set Gasket	0818 2295	0292 8815	

Disclaimer: OEM numbers are for reference only and do not imply that they are originals parts.



www.eurogasket.com.tr

To fit DEUTZ

FULL SET GASKET

Engine Model / Description	Eurogasket Part Number	OEM Part Number	Product Picture
DEUTZ F2L 511 Full Set Gasket	0818 1063	0292 9047	
DEUTZ BF6L 513 T Full Set Gasket	0818 2284	0292 8826	
DEUTZ BF8L 513 Full Set Gasket	0818 2298	0292 8812	
DEUTZ BF12L 513 Full Set Gasket	0818 2294	0292 8816	
DEUTZ F2L 514 Full Set Gasket	0770 5361	0330 5749	

Disclaimer: OEM numbers are for reference only and do not imply that they are originals parts.



www.eurogasket.com.tr

To fit **DEUTZ**

FULL SET GASKET

Engine Model / Description	Eurogasket Part Number	OEM Part Number	Product Picture
DEUTZ F3L 514 Full Set Gasket	0514 0380	0596 0720	
DEUTZ F4L 514 Full Set Gasket	0514 0480	0596 0620	
DEUTZ F6L 514 Full Set Gasket	0514 0680	0596 0420	
DEUTZ F6L 614 Full Set Gasket	0614 0680	0496 0420	
DEUTZ F6-8L 714 Full Set Gasket	0819 9522	0291 1588	

Disclaimer: OEM numbers are for reference only and do not imply that they are originals parts.



www.eurogasket.com.tr

To fit **DEUTZ**

FULL SET GASKET

Engine Model / Description	Eurogasket Part Number	OEM Part Number	Product Picture
DEUTZ F2L 912 Full Set Gasket	0818 1458	0292 9652	
DEUTZ F3L 912 Full Set Gasket	0818 1454	0292 9657	
DEUTZ F4L 912 Full Set Gasket	0818 1461	0292 9649	
DEUTZ F5L 912 Full Set Gasket	0818 1459	0292 9651	
DEUTZ F6L 912 Full Set Gasket	0818 1450	0292 9650	

Disclaimer: OEM numbers are for reference only and do not imply that they are originals parts.



www.eurogasket.com.tr

To fit **DEUTZ**

FULL SET GASKET

Engine Model / Description	Eurogasket Part Number	OEM Part Number	Product Picture
DEUTZ BF4L 913 Full Set Gasket	0818 1472	0292 9638	
DEUTZ BF6L 913 Full Set Gasket	0818 1453	0292 9657	
DEUTZ F3L 914 Full Set Gasket	0817 9599	0293 1511	
DEUTZ F4L 914 Full Set Gasket	0817 9598	0293 1512	
DEUTZ F5L 914 Full Set Gasket	0817 9597	0293 1513	

Disclaimer: OEM numbers are for reference only and do not imply that they are originals parts.



www.eurogasket.com.tr

To fit DEUTZ

FULL SET GASKET

Engine Model / Description	Eurogasket Part Number	OEM Part Number	Product Picture
DEUTZ F6L 914 Full Set Gasket	0817 9596	0293 1514	
DEUTZ F2L 1011 DEUTZ BF2L 011 Full Set Gasket	0818 2267 + 0818 2381	0292 8843 + 0292 8729	
DEUTZ F2L 1011 F DEUTZ BF2L 1011F Full Set Gasket	0818 2258 + 0818 2381	0292 8852 + 0292 8729	
DEUTZ F3L 1011 DEUTZ BF3L 1011 Full Set Gasket	0818 2266 + 0818 2381	0292 8844 + 0292 8729	
DEUTZ F3L 1011 F DEUTZ BF3M 1011 F Full Set Gasket	0818 1257 + 0818 1254	0292 9853 + 0292 9856	

Disclaimer: OEM numbers are for reference only and do not imply that they are originals parts.



www.eurogasket.com.tr

To fit DEUTZ

FULL SET GASKET

Engine Model / Description	Eurogasket Part Number	OEM Part Number	Product Picture
DEUTZ F4L 1011 DEUTZ BF4L 1011 Full Set Gasket	0818 2265 + 0818 2381	0292 8845 + 0292 8729	
DEUTZ F4L 1011 F DEUTZ BF4L 1011F Full Set Gasket	0818 1256 + 0818 1254	0292 9854 + 0292 9856	
DEUTZ BF4M 1012 Full Set Gasket	0817 9834	0293 1276	
DEUTZ BF6M 1012 Full Set Gasket	0817 9833	0293 1277	
DEUTZ BF4M 1013 Full Set Gasket	0817 9832	0293 1278	

Disclaimer: OEM numbers are for reference only and do not imply that they are originals parts.



www.eurogasket.com.tr

To fit DEUTZ

FULL SET GASKET

Engine Model / Description	Eurogasket Part Number	OEM Part Number	Product Picture
DEUTZ BF6M 1013 Full Set Gasket	0817 9831	0293 1279	
DEUTZ BF6M 1015 Full Set Gasket	0817 9632	0293 1478	
DEUTZ BF8M 1015 Full Set Gasket	0817 9631	0293 1479	
DEUTZ F3M 2011 Full Set Gasket	0817 9676	0293 1434	
DEUTZ F4M 2011 Full Set Gasket	0817 9675	0293 1435	

Disclaimer: OEM numbers are for reference only and do not imply that they are originals parts.



www.eurogasket.com.tr

To fit **DEUTZ**

FULL SET GASKET

Engine Model / Description	Eurogasket Part Number	OEM Part Number	Product Picture
DEUTZ BF4M 2012 Full Set Gasket	0817 9679	0293 1431	
DEUTZ BF6M 2012 Full Set Gasket	0817 9678 0817 9371	0293 1432 0293 1739	
DEUTZ TCD4L 2012 2V Full Set Gasket	0817 9348	0293 1762	
DEUTZ TCD6L 2012 2V Full Set Gasket	0817 9448	0293 1662	
DEUTZ TCD4L 2013 2V Full Set Gasket	0817 9347	0293 1763	

Disclaimer: OEM numbers are for reference only and do not imply that they are originals parts.



www.eurogasket.com.tr

To fit DEUTZ

FULL SET GASKET

Engine Model / Description	Eurogasket Part Number	OEM Part Number	Product Picture
DEUTZ TCD6L 2013 2V Full Set Gasket	0817 9447	0293 1663	
DEUTZ FL 1011 Conversion Set Gasket (All Type)	0818 2381	0292 8729	
DEUTZ FL 1011 F Conversion Set Gasket (All Type)	0817 9992	0293 1118	

Disclaimer: OEM numbers are for reference only and do not imply that they are originals parts.



www.eurogasket.com.tr

To fit DEUTZ

HEAD SET GASKET

Engine Model / Description	Eurogasket Part Number	OEM Part Number	Product Picture
DEUTZ FL 413 V Head Set Gasket	0819 9594	0291 1516	
DEUTZ FL 413 F / 513 Head Set Gasket	0818 2290	0292 8810	
DEUTZ FL 413 R Head Set Gasket	0819 9594	0291 1516	
DEUTZ FL 413 FR Head Set Gasket	0819 9550	0291 1550	
DEUTZ FL 511 Head Set Gasket	0818 1050	0292 9050	

Disclaimer: OEM numbers are for reference only and do not imply that they are originals parts.



www.eurogasket.com.tr

To fit **DEUTZ**

HEAD SET GASKET

Engine Model / Description	Eurogasket Part Number	OEM Part Number	Product Picture
DEUTZ FL 514 Head Set Gasket	0770 5361	0330 5749	
DEUTZ F6L 614 Head Set Gasket	0819 0946	0291 0164	
DEUTZ FL 714 Head Set Gasket	0819 9524	0291 1586	
DEUTZ FL 716 Head Set Gasket	0819 0932	0291 0178	
DEUTZ FL 816 Head Set Gasket	0819 9552	0291 1558	

Disclaimer: OEM numbers are for reference only and do not imply that they are originals parts.



www.eurogasket.com.tr

To fit DEUTZ

HEAD SET GASKET

Engine Model / Description	Eurogasket Part Number	OEM Part Number	Product Picture
DEUTZ FL 912 / 913 Head Set Gasket	0818 2116	0292 8994	
DEUTZ FL 914 Head Set Gasket	0817 9684	0293 1426	
DEUTZ F2L 1011 Head Set Gasket	0818 2267	0292 8843	
DEUTZ F2L 1011 F Head Set Gasket	0818 1258	0292 9852	
DEUTZ F3L 1011 F Head Set Gasket	0818 1257	0292 9853	

Disclaimer: OEM numbers are for reference only and do not imply that they are originals parts.



www.eurogasket.com.tr

To fit **DEUTZ**

HEAD SET GASKET

Engine Model / Description	Eurogasket Part Number	OEM Part Number	Product Picture
DEUTZ F3L 1011 Head Set Gasket	0818 2266	0292 8844	
DEUTZ BF3M 1011 F Head Set Gasket	0817 9993	0293 1117	
DEUTZ BF4L 1011 Head Set Gasket	0818 2231	0292 8879	
DEUTZ F4L 1011 Head Set Gasket	0818 2265	0292 8845	
DEUTZ BF4M 1011F Head Set Gasket	0817 9969	0293 1141	

Disclaimer: OEM numbers are for reference only and do not imply that they are originals parts.



www.eurogasket.com.tr

To fit **DEUTZ**

HEAD SET GASKET

Engine Model / Description	Eurogasket Part Number	OEM Part Number	Product Picture
DEUTZ F4L 1011 F Head Set Gasket	0818 2267	0292 9854	
DEUTZ BF4L 1011 F Head Set Gasket	0818 1255	0292 9855	

Disclaimer: OEM numbers are for reference only and do not imply that they are originals parts.



www.eurogasket.com.tr

To fit **DEUTZ**

CYLINDER HEAD GASKET

Engine Model / Description	Eurogasket Part Number	OEM Part Number	Product Picture
<p>DEUTZ F2L 1011 Cylinder Head Gasket</p> <p>1 Notch 2 Notch 3 Notch</p>	<p>0693 0535 0693 0534 0693 0533</p>	<p>0417 0575 0417 0576 0417 0577</p>	
<p>DEUTZ F2L 1011 F Cylinder Head Gasket</p> <p>1 Notch 2 Notch 3 Notch</p>	<p>0693 2249 0693 2248 0693 2247</p>	<p>0417 8861 0417 8862 0417 8863</p>	
<p>DEUTZ F3L 1011 Cylinder Head Gasket</p> <p>1 Notch 2 Notch 3 Notch</p>	<p>0693 0538 0693 0537 0693 0536</p>	<p>0417 0572 0417 0573 0417 0574</p>	
<p>DEUTZ F3L 1011 F Cylinder Head Gasket</p> <p>1 Notch 2 Notch 3 Notch</p>	<p>0693 2256 0693 2255 0693 2254</p>	<p>0417 8854 0417 8855 0417 8856</p>	
<p>DEUTZ F4L 1011 Cylinder Head Gasket</p> <p>1 Notch 2 Notch 3 Notch</p>	<p>0693 0541 0693 0530 0693 0539</p>	<p>0417 0569 0417 0570 0417 0571</p>	

Disclaimer: OEM numbers are for reference only and do not imply that they are originals parts.



www.eurogasket.com.tr

To fit DEUTZ

CYLINDER HEAD GASKET

Engine Model / Description	Eurogasket Part Number	OEM Part Number	Product Picture
DEUTZ F4L 1011 F Cylinder Head Gasket 1 Notch 2 Notch 3 Notch	0693 2243 0693 2242 0693 2241	0417 8867 0417 8868 0417 8869	
DEUTZ BF4M 1012 Cylinder Head Gasket 1 Notch 2 Notch 3 Notch	0680 1219 0680 1218 0680 1217	0420 9891 0420 9892 0420 9893	
DEUTZ BF6M 1012 Cylinder Head Gasket 1 Notch 2 Notch 3 Notch	0680 1215 0680 1214 0680 1213	0420 9895 0420 9896 0420 9897	
DEUTZ BF4M 1013 Cylinder Head Gasket 1 Notch 2 Notch 3 Notch	0680 9548 0680 9547 0680 9546	0420 1562 0420 1563 0420 1564	
DEUTZ BF6M 1013 Cylinder Head Gasket 1 Notch 2 Notch 3 Notch	0680 9551 0680 9540 0680 9549	0420 1559 0420 1560 0420 1561	

Disclaimer: OEM numbers are for reference only and do not imply that they are originals parts.



www.eurogasket.com.tr

To fit **DEUTZ**

CYLINDER HEAD GASKET

Engine Model / Description	Eurogasket Part Number	OEM Part Number	Product Picture
DEUTZ BFL 1015 Cylinder Head Gasket 1 Notch 2 Notch 3 Notch	0688 8106 0688 8104 0688 8102	0422 2904 0422 2906 0422 2908	
DEUTZ BFL 1015 Cylinder Head Gasket 1 Notch 2 Notch 3 Notch (New Model)	0684 6006 0684 6005 0684 6004	0426 4004 0426 4005 0426 4006	
DEUTZ F2L 2011 DEUTZ F2M 2011 Cylinder Head Gasket 1 Notch 2 Notch 3 Notch	0682 0202 0682 0201 0682 0290	0428 0808 0428 0809 0428 0810	
DEUTZ F3L 2011 DEUTZ F3M 2011 Cylinder Head Gasket 1 Notch 2 Notch 3 Notch	0682 0298 0682 0297 0682 0296	0428 0812 0428 0813 0428 0814	
DEUTZ F3L 2011 DEUTZ F3M 2011 Cylinder Head Gasket 1 Notch 2 Notch 3 Notch (Metal)	0682 4526 0682 4525 0682 4524	0428 6584 0428 6585 0428 6586	

Disclaimer: OEM numbers are for reference only and do not imply that they are originals parts.



www.eurogasket.com.tr

To fit **DEUTZ**

CYLINDER HEAD GASKET

Engine Model / Description	Eurogasket Part Number	OEM Part Number	Product Picture
DEUTZ F4L 2011 DEUTZ F4M 2011 Cylinder Head Gasket 1 Notch 2 Notch 3 Notch	0682 0294 0682 0293 0682 0292	0428 0816 0428 0817 0428 0818	
DEUTZ F4L 2011 DEUTZ F4M 2011 Cylinder Head Gasket 1 Notch 2 Notch 3 Notch (Metal)	0682 3685 0682 3684 0682 3683	0428 7425 0428 7426 0428 7427	
DEUTZ BF4M 2012 DEUTZ TCD4L 2012 2V Cylinder Head Gasket 1 Notch 2 Notch 3 Notch	0682 1602 0682 1603 0682 1604	0428 9408 0428 9407 0428 9406	
DEUTZ BF6M 2012 Cylinder Head Gasket 1 Notch 2 Notch 3 Notch	0682 5827 0682 5826 0682 5825	0428 5283 0428 5284 0428 5285	
DEUTZ TCD6L 2012 2V Cylinder Head Gasket 1 Notch 2 Notch 3 Notch	0682 1605 0682 1606 0682 1607	0428 9405 0428 9404 0428 9403	

Disclaimer: OEM numbers are for reference only and do not imply that they are originals parts.



www.eurogasket.com.tr

To fit **DEUTZ**

CYLINDER HEAD GASKET

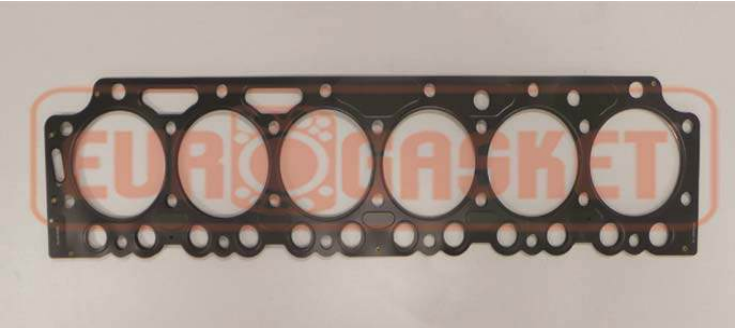
Engine Model / Description	Eurogasket Part Number	OEM Part Number	Product Picture
DEUTZ TCD6L 2013 2V Cylinder Head Gasket 1 Notch 2 Notch 3 Notch	0681 6916 0681 6915 0681 6914	0429 4194 0429 4195 0429 4196	

Disclaimer: OEM numbers are for reference only and do not imply that they are originals parts.



www.eurogasket.com.tr

To fit DEUTZ

OIL PAN GASKET

Engine Model / Description	Eurogasket Part Number	OEM Part Number	Product Picture
DEUTZ F6L 413 / 413F / 413 V Oil Pan Gasket	0860 7991	0240 3119	
DEUTZ F8L 413 / 413F/ V Oil Pan Gasket	0897 9533	0213 1577	
DEUTZ F4L 413R / FR Oil Pan Gasket	0692 2801	0418 8209	
DEUTZ F6L 413R / FR /513 Oil Pan Gasket	0692 2890	0418 8210	
DEUTZ F12L 413 / F / V Oil Pan Gasket	0897 9531	0213 1579	

Disclaimer: OEM numbers are for reference only and do not imply that they are originals parts.



www.eurogasket.com.tr

To fit **DEUTZ**

OIL PAN GASKET

Engine Model / Description	Eurogasket Part Number	OEM Part Number	Product Picture
DEUTZ F3L 912 / 913 Oil Pan Gasket	0774 8537	0336 2573	
DEUTZ F3L 912 / 913 Oil Pan Gasket (Thin)	0774 8537	0336 2573	
DEUTZ F4L 912 Oil Pan Gasket (Thick) 4 Pcs	0897 4391	0213 6719	
DEUTZ F4L 912 Oil Pan Gasket (Thick)	0897 4391	0213 6719	
DEUTZ F4L 912 Oil Pan Gasket (Thin)	0774 8536	0336 2574	

Disclaimer: OEM numbers are for reference only and do not imply that they are originals parts.



www.eurogasket.com.tr

To fit **DEUTZ**

OIL PAN GASKET

Engine Model / Description	Eurogasket Part Number	OEM Part Number	Product Picture
DEUTZ F5L 912 Oil Pan Gasket	0886 0177	0224 0933	
DEUTZ F6L 912 / 913 Oil Pan Gasket (Thick)	0897 4380	0213 6720	
DEUTZ F6L 912 / 913 Oil Pan Gasket (Thick) 4 Pcs	0897 4380	0213 6720	
DEUTZ F6L 912 / 913 Oil Pan Gasket (Thin)	0774 8529	0336 2581	
DEUTZ BF4M 1012 DEUTZ BF4M 2012 Oil Pan Gasket	0680 6658	0420 4452	



Disclaimer: OEM numbers are for reference only and do not imply that they are originals parts.



www.eurogasket.com.tr

To fit **DEUTZ**

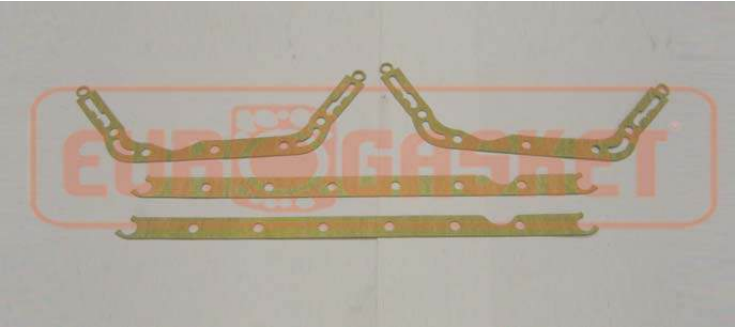
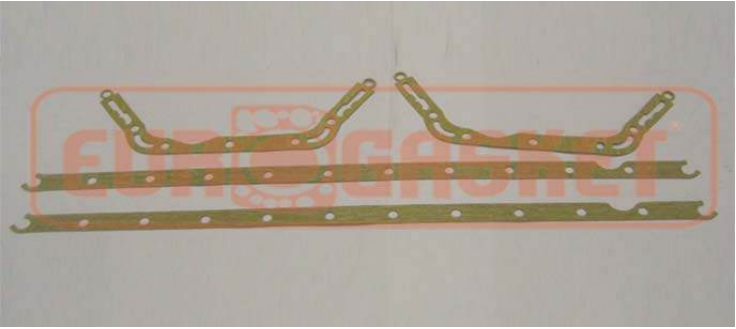
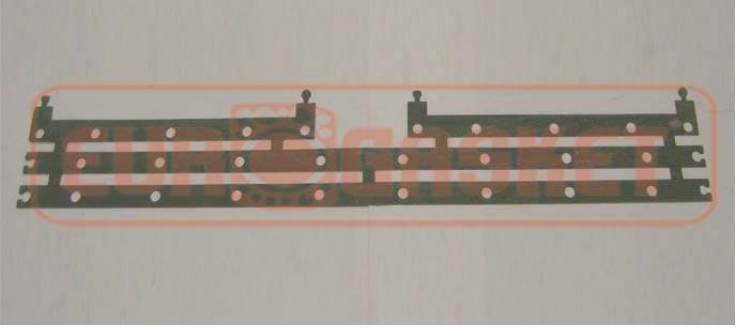
OIL PAN GASKET

Engine Model / Description	Eurogasket Part Number	OEM Part Number	Product Picture
DEUTZ BF4M 1013 DEUTZ BF4M 2013 Oil Pan Gasket	0680 6652	0420 4458	
DEUTZ BF6M 1013 DEUTZ BF6M 2013 Oil Pan Gasket	0680 6651	0420 4459	
DEUTZ BF6M 1015 DEUTZ TCD6V 2015 Oil Pan Gasket	0684 7534	0426 3576	
DEUTZ BF8M 1015 DEUTZ TCD8V 2015 Oil Pan Gasket	0684 7534	0426 3578	

Disclaimer: OEM numbers are for reference only and do not imply that they are originals parts.



www.eurogasket.com.tr

To fit **DEUTZ**

VALVE COVER GASKET

Product Details	Product Picture	Product Details	Product Picture
<p>DEUTZ FL 413 Valve Cover Gasket</p> <p>OEM No: 0240 2812</p> <p>Eurogasket No: 0860 8298</p>		<p>DEUTZ FL 413 F/ /FR/513 Valve Cover Gasket</p> <p>OEM No: 0414 7308</p> <p>Eurogasket No: 0696 3702</p>	
<p>DEUTZ FL 514 / 614 Valve Cover Gasket</p> <p>OEM No: 0336 5761</p> <p>Eurogasket No: 0774 5349</p>		<p>DEUTZ F6M 716 Valve Cover Gasket</p> <p>OEM No: 0347 0138</p> <p>Eurogasket No: 0763 0972</p>	
<p>DEUTZ FL 511 DEUTZ FL 912 DEUTZ FL 913 Valve Cover Gasket</p> <p>OEM No: 0337 1692</p> <p>Eurogasket No: 0773 9418</p>		<p>DEUTZ FL 511 DEUTZ FL 912 DEUTZ FL 913 Valve Cover Gasket</p> <p>OEM No: 0337 1692</p> <p>Eurogasket No: 0773 9418</p>	
<p>DEUTZ F2L 1011 F DEUTZ F2L 2011 Valve Cover Gasket</p> <p>OEM No: 0417 9845</p> <p>Eurogasket No: 0693 1265</p>		<p>DEUTZ F2L 1011 Valve Cover Gasket</p> <p>OEM No: 0417 3857</p> <p>Eurogasket No: 0693 7253</p>	
<p>DEUTZ F3L 1011 Valve Cover Gasket</p> <p>OEM No: 0417 3858</p> <p>Eurogasket No: 0693 7252</p>		<p>DEUTZ F3L 1011 F DEUTZ F3L 2011 Valve Cover Gasket</p> <p>OEM No: 0417 9846</p> <p>Eurogasket No: 0693 1264</p>	

Disclaimer: OEM numbers are for reference only and do not imply that they are originals parts.



www.eurogasket.com.tr

To fit **DEUTZ**

VALVE COVER GASKET

Product Details	Product Picture	Product Details	Product Picture
<p>DEUTZ F4L 1011 F Valve Cover Gasket</p> <p>OEM No: 0417 3859</p> <p>Eurogasket No: 0693 7251</p>		<p>DEUTZ B/F4L 1011 DEUTZ F4L/M 2011 Valve Cover Gasket</p> <p>OEM No: 0417 9847</p> <p>Eurogasket No: 0693 1263</p>	
<p>DEUTZ BF4M 1012 Valve Cover Gasket (Metal)</p> <p>OEM No: 0428 3391</p> <p>Eurogasket No: 0682 7719</p>		<p>DEUTZ BF4M 1012 Valve Cover Gasket</p> <p>OEM No: 0419 8796</p> <p>Eurogasket No: 0691 2314</p>	
<p>DEUTZ BF6M 1012 Valve Cover Gasket</p> <p>OEM No: 0419 8969</p> <p>Eurogasket No: 0691 2141</p>		<p>DEUTZ BF4M 1013 Valve Cover Gasket</p> <p>OEM No: 0420 5895</p> <p>Eurogasket No: 0680 5215</p>	
<p>DEUTZ BF6M 1013 Valve Cover Gasket</p> <p>OEM No: 0420 5894</p> <p>Eurogasket No: 0680 5216</p>		<p>DEUTZ BFL 1015 Valve Cover Gasket</p> <p>OEM No: 0422 4081</p> <p>Eurogasket No: 0688 6029</p>	
<p>DEUTZ BFL 1015 Valve Cover Gasket</p> <p>OEM No: 0422 1064</p> <p>Eurogasket No: 0688 9046</p>		<p>DEUTZ BFL 1015 Valve Cover Gasket</p> <p>OEM No: 0422 4392</p> <p>Eurogasket No: 0688 6718</p>	







Disclaimer: OEM numbers are for reference only and do not imply that they are originals parts.

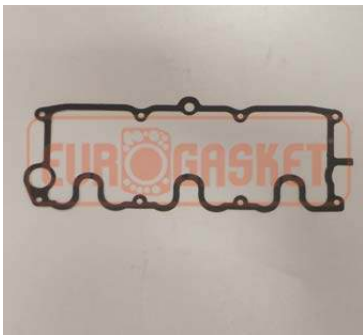

www.eurogasket.com.tr

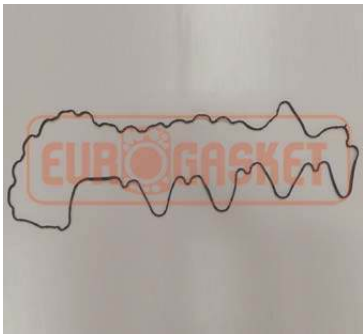
To fit **DEUTZ**

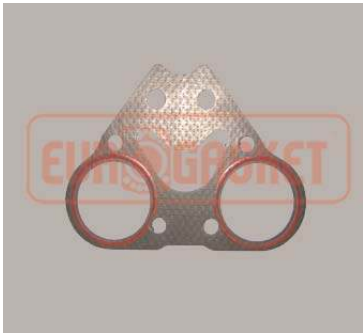
VALVE COVER GASKET

Product Details		Product Picture	
<p>DEUTZ BF3M 2011 Valve Cover Gasket</p> <p>OEM No: 0428 0463</p> <p>Eurogasket No: 0682 0647</p>		<p>DEUTZ F4L 2011 Valve Cover Gasket</p> <p>OEM No: 0427 1076</p> <p>Eurogasket No: 0683 9034</p>	
<p>DEUTZ TCD6L 2012 2V Valve Cover Gasket</p> <p>OEM No: 0429 1418</p> <p>Eurogasket No: 0681 9692</p>		<p>DEUTZ TCDL 2013 2V Valve Cover Gasket</p> <p>OEM No: 0429 1468</p> <p>Eurogasket No: 0681 9642</p>	
<p>DEUTZ FL 413F / FR/513 Gasket</p> <p>OEM No: 0418 4091</p> <p>Eurogasket No: 0692 6019</p>		<p>DEUTZ FL 914 Valve Cover Gasket</p> <p>OEM No: 0423 4001</p> <p>Eurogasket No: 0687 6009</p>	
<p>DEUTZ Valve Cover Gasket</p> <p>OEM No: 1227 7677</p> <p>Eurogasket No: 9883 3433</p>			

Disclaimer: OEM numbers are for reference only and do not imply that they are originals parts.



www.eurogasket.com.tr

To fit **DEUTZ**

INTAKE MANIFOLD GASKET

Product Details	Product Picture	Product Details	Product Picture
<p>DEUTZ FL 413 / 413F/513 Intake Manifold Gasket</p> <p>OEM No: 0414 1486</p> <p>Eurogasket No: 0696 9624</p> <p>Elring No : 349 488</p>		<p>DEUTZ FL 912 / 913 Intake Manifold Gasket</p> <p>OEM No: 0223 0704</p> <p>Eurogasket No: 0887 0306</p>	
<p>DEUTZ FL 1011 Intake Manifold Gasket</p> <p>OEM No: 0417 3861</p> <p>Eurogasket No: 0693 7249</p>		<p>DEUTZ BFM 1012 Intake Manifold Gasket</p> <p>OEM No: 0419 8387</p> <p>Eurogasket No: 0691 2723</p>	
<p>DEUTZ BFM 1013 Intake Manifold Gasket</p> <p>OEM No: 0420 0095</p> <p>Eurogasket No: 0680 0015</p>		<p>DEUTZ BFM 1015 Intake Manifold Gasket</p> <p>OEM No: 0422 0148</p> <p>Eurogasket No: 0688 0962</p>	

Disclaimer: OEM numbers are for reference only and do not imply that they are originals parts.



www.eurogasket.com.tr

To fit **DEUTZ**

EXHAUST MANIFOLD GASKET

Product Details	Product Picture	Product Details	Product Picture
<p>DEUTZ FL 413 / 513 Exhaust Manifold Gasket (3 Hole)</p> <p>OEM No: 0418 4903</p> <p>Eurogasket No: 0692 6107</p> <p>Elring No: 107 698</p>		<p>DEUTZ FL 413 Exhaust Manifold Gasket</p> <p>OEM No: 0336 2170</p> <p>Eurogasket No: 0774 8930</p>	
<p>DEUTZ FL 514 / 614 Exhaust Manifold Gasket</p> <p>OEM No: 0292 9305</p> <p>Eurogasket No: 0818 1705</p>		<p>DEUTZ FL 912 Exhaust Manifold Gasket</p> <p>OEM No: 0337 1689</p> <p>Eurogasket No: 0773 9421</p>	
<p>DEUTZ FL 511 - FL 912 DEUTZ FL 913 DEUTZ FL 914 Exhaust Manifold Gasket New Type</p> <p>OEM No: 0423 3529</p> <p>Eurogasket No: 0687 7581</p>		<p>DEUTZ FL 912 /913 /914 Gasket Donut</p> <p>OEM No: 0415 7360</p> <p>Eurogasket No: 0395 3740</p>	
<p>DEUTZ FL 1011 / 2011 Exhaust Manifold Gasket</p> <p>OEM No: 0417 3862</p> <p>Eurogasket No: 0693 7248</p>		<p>DEUTZ BFM 1012 / 1013 DEUTZ BFM 2012 Exhaust Manifold Gasket</p> <p>OEM No: 0428 3299</p> <p>Eurogasket No: 0682 7811</p>	

Disclaimer: OEM numbers are for reference only and do not imply that they are originals parts.



www.eurogasket.com.tr

To fit **DEUTZ**

EXHAUST MANIFOLD GASKET

Product Details		Product Picture	
<p>DEUTZ BFM 1015 Exhaust Manifold Gasket</p> <p>OEM No: 0422 3020</p> <p>Eurogasket No: 0688 7080</p>		<p>DEUTZ TCD 2013 Exhaust Manifold Gasket</p> <p>OEM No: 0429 2820</p> <p>Eurogasket No: 0681 8280</p>	

Disclaimer: OEM numbers are for reference only and do not imply that they are originals parts.



www.eurogasket.com.tr

To fit **DEUTZ**

TURBO GASKET

Product Details	Product Picture	Product Details	Product Picture
<p>DEUTZ FL 913 Turbo Gasket</p> <p>OEM No: 0418 2519</p> <p>Eurogasket No: 0692 8591</p>		<p>DEUTZ FL 913 Turbo Gasket</p> <p>OEM No: 0418 2520</p> <p>Eurogasket No: 0692 8580</p>	
<p>DEUTZ FL 913 Turbo Gasket</p> <p>OEM No: 0415 7260</p> <p>Eurogasket No: 0695 3840</p>		<p>DEUTZ FL 913 Turbo Gasket</p> <p>OEM No: 0418 2521</p> <p>Eurogasket No: 0692 8589</p>	
<p>DEUTZ BF4M 1013 DEUTZ BF6M 1012 Turbo Gasket</p> <p>OEM No: 0420 9206</p> <p>Eurogasket No: 0680 1804</p>		<p>DEUTZ F/BF4L 1011F DEUTZ BF4M 1012 Turbo Gasket</p> <p>OEM No: 0417 2446</p> <p>Eurogasket No: 0693 8664</p>	
<p>DEUTZ BF4M 1013 DEUTZ BF6M 1012 Turbo Gasket</p> <p>OEM No: 0415 7246</p> <p>Eurogasket No: 0695 3864</p>		<p>DEUTZ BF6M 1013 Turbo Gasket</p> <p>OEM No: 0420 9203</p> <p>Eurogasket No: 0680 1807</p>	
<p>DEUTZ BF4M 1012 Turbo Gasket</p> <p>OEM No: 0420 9196</p> <p>Eurogasket No: 0680 1914</p>		<p>DEUTZ BF6M 1013 Turbo Gasket</p> <p>OEM No: 0420 9205</p> <p>Eurogasket No: 0680 1805</p>	

Disclaimer: OEM numbers are for reference only and do not imply that they are originals parts.



www.eurogasket.com.tr

To fit DEUTZ

GASKET

Engine Model / Description	Eurogasket Part Number	OEM Part Number	Product Picture
DEUTZ BFM 1012 / BFM 1013 Gasket	0680 8920	0420 2180	
DEUTZ BFM 1012 / BFM 2012 Gasket	0680 8136	0420 2974	
DEUTZ BFM 1012 / BFM 2012 Water Pump Gasket	0680 8135	0420 2975	
DEUTZ BFM 1013 Water Pump Gasket	0691 2142	0419 8968	
DEUTZ BFM 2012 Oil Radiator Cover Gasket	0685 6207	0425 4803	

Disclaimer: OEM numbers are for reference only and do not imply that they are originals parts.



www.eurogasket.com.tr

To fit DEUTZ

GASKET

Engine Model / Description	Eurogasket Part Number	OEM Part Number	Product Picture
DEUTZ Axle Gasket	0603 0665	0407 0445	

Disclaimer: OEM numbers are for reference only and do not imply that they are originals parts.



www.eurogasket.com.tr

To fit DEUTZ

GASKET

Engine Model / Description	Eurogasket Part Number	OEM Part Number	Product Picture
DEUTZ Gasket	0600 0461	0400 0649	
DEUTZ Gasket	0603 0532	0407 0578	
DEUTZ TCD 2013 Oil Radiator Rubber	0999 2300	0111 8700	
DEUTZ TCD 2013 Oil Radiator Rubber	0685 8713	0425 2397	
DEUTZ TCD 2013 Oil Radiator Cover Rubber	0685 8873	0425 2237	

Disclaimer: OEM numbers are for reference only and do not imply that they are originals parts.



www.eurogasket.com.tr

To fit **DEUTZ**

GASKET

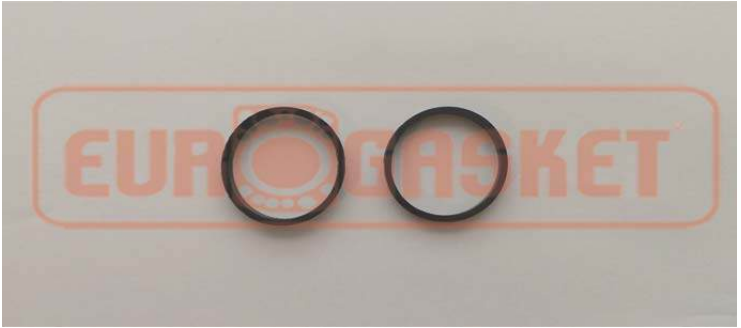
Engine Model / Description	Eurogasket Part Number	OEM Part Number	Product Picture
DEUTZ TCD 2013 Oil Radiator Rubber	0685 8108	0425 2902	

Disclaimer: OEM numbers are for reference only and do not imply that they are originals parts.



www.eurogasket.com.tr

To fit DEUTZ

SHIM

Engine Model / Description	Eurogasket Part Number	OEM Part Number	Product Picture
DEUTZ FL 413F / 513 Shim 0,50 mm Shim 0,70 mm Shim 1,00 mm	0692 7861 0692 7850 0692 7859	0418 3249 0418 3250 0418 3251	
DEUTZ FL 413 Shim 0,10 mm Shim 0,20 mm Shim 0,30 mm Shim 0,50 mm Shim 0,70 mm Shim 1,00 mm	0860 7960 0860 7969 0860 7968 0869 1004 0696 1378 0696 1377	0240 3140 0240 3141 0240 3142 0241 9006 0414 9732 0414 9733	
DEUTZ F6-8M 716 Shim 1,00 mm Shim 1,50 mm	0773 7689 0895 2638	0337 3421 0215 8472	
DEUTZ FL 912 / 913 Shim 0,20 mm Shim 0,30 mm Shim 0,50 mm Shim 0,50 mm (Notch) Shim 0,80 mm Shim 1,00 mm	0897 3854 0695 7752 0687 9678 0887 8147 0695 0846 0887 1779	0213 7256 0415 3358 0423 1432 0223 2963 0415 0264 0223 9331	
DEUTZ FL 912 / 913 Shim 1,10 mm Shim 1,15 mm Shim 1,20 mm Shim 1,25 mm Shim 1,30 mm Shim 1,40 mm Shim 1,50 mm Shim 1,60 mm	0695 3456 0695 3455 0695 3442 0695 3453 0695 3452 0695 3644 0695 3643 0695 3630	0415 7654 0415 7655 0415 7668 0415 7657 0415 7658 0415 7466 0415 7467 0415 7470	

Disclaimer: OEM numbers are for reference only and do not imply that they are originals parts.



www.eurogasket.com.tr

To fit **DEUTZ**

SHIM

			Product Picture
Engine Model / Description	Eurogasket Part Number	OEM Part Number	

Disclaimer: OEM numbers are for reference only and do not imply that they are originals parts.



www.eurogasket.com.tr

To fit **DEUTZ**

RUBBER & SEAL

Product Details		Product Picture	
<p>DEUTZ FL 912 / 913 / 914 Pushrod Seal</p> <p>OEM No: 0223 2840</p> <p>Eurogasket No: 0887 8260</p>		<p>DEUTZ FL 716 / 816 Sealing Ring</p> <p>OEM No: 0337 3415</p> <p>Eurogasket No: 0773 7695</p>	
<p>DEUTZ FL 716 / 816 Sealing Ring</p> <p>OEM No: 0337 3414</p> <p>Eurogasket No: 0773 7696</p>		<p>DEUTZ FL 912 / 913 Injector Rubber – 1 Hole</p> <p>OEM No: 0116 0592</p> <p>Eurogasket No: 0994 0518</p>	
<p>DEUTZ FL 912 / 913 Injector Rubber – 2 Hole</p> <p>OEM No: 0336 1809</p> <p>Eurogasket No: 0774 9201</p>		<p>DEUTZ FL 1011 / 2011 Valve Stem Seal</p> <p>OEM No: 0415 3728</p> <p>Eurogasket No: 0695 7382</p>	
<p>DEUTZ FL 912 / 913 Injector Rubber – 8 Hole</p> <p>OEM No: 0210 1802</p> <p>Eurogasket No: 0890 9208</p>			

Disclaimer: OEM numbers are for reference only and do not imply that they are originals parts.



www.eurogasket.com.tr

SEALS – To Fit DEUTZ



OEM Part Number	DPH Part Number	Eling Part Number	Corteco Part Number	Application	Dimensions
0009 4765	111397			Crankshaft	160 x 190 x 15 FPM
103 2872	113618		01032872	Crankshaft	12 x 16 x 3 NBR
113 2992	113739				25 x 42 x 10/7 FPM
115 3906	37510			Steering	45 x 72 x 15 NBR
115 4490	18236		01003181	Crankshaft	45 x 65 x 10 NBR
116 0383	68548	043095		Crankshaft	150 x 172 x 18 MVQ
116 0652	17697	164500		Crankshaft	28 x 40 x 7 NBR
116 0655	113738				28 x 47 x 10/7 FPM
116 0750	17754		12010885	Crankshaft	30 x 50 x 10 NBR
116 0752	32023				30 x 62 x 12 NBR
116 0989	17619			Crankshaft	25 x 40 x 10 NBR
116 2568	98129			Gear Box	25 x 42 x 10 MVQ
116 2569	98091				28 x 47 x 10 MVQ
116 3205	81629			Crankshaft	60 x 80 x 10 NBR
116 3273	82139		01029927	Crankshaft	30 x 42 x 8/7 NBR
116 3316	68547	042676		Crankshaft	95 x 120 x 12 ACM
116 4594	82791			Engine	25 x 62 x 10 MVQ
116 5286	18565	494402		Crankshaft	68 x 85 x 10 NBR
116 7518	6713	109657		Front-Rear Axle	150 x 180 x 13 NBR
116 7518	48063			Front-Rear Axle	150 x 180 x 11/13 NBR
117 0229	19876			F4L514	105 x 130 x 13 NBR
117 2559	118613		12011664	Crankshaft	22 x 35 x 7 FPM
117 4560	82475		12014404	Differential	42 x 56 x 7 FPM
117 5787	35050			Crankshaft	42 x 62 x 10 ACM
117 5820	111397			Crankshaft	160 x 190 x 15 FPM
121 6319	68545			Injection	22 x 47 x 10 NBR
121 6330	68543	039918		Gear Box	40 x 52 x 7 NBR
121 6338	68546	055506			17 x 37 x 10 NBR
1215 2257	15246		12012579	Crankshaft	90 x 110 x 12 FPM
1215 2280	114419		20020505	Crankshaft	133 x 160 x 15 FPM
214 8905	82047		12012580	Crankshaft	100 x 120 x 15 FPM
223 4133	93422		12012095	Crankshaft	65 x 85 x 13/12,5 FPM
223 4134	48305	033376	12012148	Crankshaft	115 x 140 x 16 FPM
223 4498	82138	352136	01034681	Crankshaft	62 x 80 x 12/11 MVQ
223 7010	114328		01018323	Gear Box	25 x 42 x 8 FPM
241 3332	82048			Crankshaft	105 x 130 x 15 FPM
241 4248	95149		01026520	Crankshaft	45 x 65 x 10 FPM

Disclaimer: OEM numbers are for reference only and do not imply that they are originals parts.



www.eurogasket.com.tr

SEALS – To Fit DEUTZ



OEM Part Number	DPH Part Number	Elring Part Number	Corteco Part Number	Application	Dimensions
241 6507	61099			Crankshaft	90 x 110 x 15 MVQ
241 6507	94728	331198		Crankshaft	90 x 110 x 15 FPM
241 8366	61098			Crankshaft	105 x 130 x 15 MVQ
241 8366	82048		12012581	Crankshaft	105 x 130 x 15 FPM
241 9323	82793	462977		Fuel Injection	25 x 40 x 10 FPM
242 1819	82047	756121	12012580	Crankshaft	100 x 120 x 15 FPM
242 1819	61100			Crankshaft	100 x 120 x 15 MVQ
242 1820	82048	756148	12012581	Crankshaft	105 x 130 x 15 FPM
242 1820	61098			Crankshaft	105 x 130 x 15 MVQ
242 7066	82796			Crankshaft	45 x 62 x 10 MVQ
242 7225	82799	830887	01016937	Crankshaft	135 x 160 x 16/13 FPM
247 5845	94932	105457		Gear Box	120 x 140 x 13 NBR
342 7559	82334	044636		Wheel Hub	104 x 130 x 15/33 NBR
414 2503	82797	830879	01016936	Crankshaft	95 x 130 x 12/13 FPM
414 4843	95149			Engine	45 x 65 x 10 FPM
414 4856	97167			Crankshaft	45 x 72 x 10 FPM
414 6007	82338		01016938		95 x 120 x 13/12 FPM
414 8451	82791			Engine	25 x 62 x 10 MVQ
414 8959	114330		01029747	Crankshaft	25 x 45 x 10 FPM
415 0782	93422	033457	12012095	Crankshaft	65 x 85 x 13/12,5 FPM
415 0783	48305	033376	12012148	Crankshaft	115 x 140 x 16 FPM
415 2348	93422	033457		Crankshaft	65 x 85 x 13/12,5 FPM
415 2349	48305	033376	12012148	Crankshaft	115 x 140 x 16 FPM
415 4144	80375		01029745	Crankshaft	65 x 85 x 10,5 FPM
415 8766	21472		01030093	Crankshaft	18 x 25 x 6 NBR
416 0518	94526			Crankshaft	22 x 35 x 7 MVQ
417 5433	109580	746310	12019078	Crankshaft	105 x 125 x 13 ACM
417 5434	109582	746300	01032068	Crankshaft	55 x 75 x 10 ACM
417 5435	109584			Crankshaft	45 x 60 x 8 ACM
418 0665	82795			Engine	45 x 65 x 10 MVQ
418 2347	94249	462994		Engine	45 x 62 x 10 FPM
418 7438	95149	763781	01026520	Crankshaft	45 x 65 x 10 FPM
423 0193	48305	033376		Crankshaft	115 x 140 x 16 FPM
423 0392	48305	033376	12012148	Crankshaft	115 x 140 x 16 FPM
423 2266	80375	033459	20020386	BF6L912/913	68 x 85 x 10,5 FPM/ACM
423 2267	115617	033377	20020387	Crankshaft	115 x 140 x 13,5 FPM/ACM
425 3333	96235	084610	01027763	Crankshaft	130 x 150 x 13 FPM/ACM

Disclaimer: OEM numbers are for reference only and do not imply that they are originals parts.



to fit- IVECO



www.eurogasket.com.tr

To fit IVECO

FULL SET GASKET

Engine Model / Description	Eurogasket Part Number	OEM Part Number	Product Picture
<p>IVECO 65 E12 EUROCARGO Full Set Gasket 4 Cyl. Ø104</p>	<p>0082 100</p>		
<p>IVECO 170.30-t-190 36-330.36 190.30 H-220.30-240.30-330.30 190.33/190.36 Ts BUS 370.30 Full Set Gasket 6 Cyl. Ø137</p>	<p>910 2225</p>	<p>190 8885 Elring No: 018 040</p>	
<p>IVECO 180E 42-190E 42-260 E42 190E 31 Hy-240 E42 Ps 440 E37 EUROTECH/EUROSTAR 440E 37 -440 E42 T/P 720 Full Set Gasket</p>	<p>0081 500</p>		
<p>IVECO 302 BUS – 303 BUS 306 BUS 405-410-411 682 N3-682 N4-682 T3 682 T4 690 N1-690 N2-690T1 Full Set Gasket 6 Cyl. Ø130 x 145</p>	<p>910 2058</p>	<p>190 8052</p>	
<p>IVECO 159 Nt-160 Nc-160 Nt 4678902 160R 308L-343R-343 T 418A 418 Ac-418 AL Mot.8200.03 684 T9.2 TON 10308cc Full Set Gasket 6 Cyl. Ø125</p>	<p>0082 000</p>		

Disclaimer: OEM numbers are for reference only and do not imply that they are originals parts.



www.eurogasket.com.tr

To fit IVECO

FULL SET GASKET

Engine Model / Description	Eurogasket Part Number	OEM Part Number	Product Picture
<p>IVECO</p> <p>170.35 170 Nc 35 190 Nc 33 220.35 260 Pc260.35 330 Pc/Pt V MOTOR 8280.02 380.35</p> <p>Full Set Gasket 8 Cyl. Ø145</p>	0081 100		
<p>IVECO</p> <p>Mot 8200.02.220</p> <p>Full Set Gasket</p>	910 88 40	190 22 60	
<p>IVECO</p> <p>Mot 8210.02 697 N</p> <p>Full Set Gasket</p>	910 22 28	190 88 82	
<p>IVECO</p> <p>Mot 8060.25 R-U Mot 8060.45 B-L-M</p> <p>Full Set Gasket</p>	910 32 57	<p>190 78 53</p> <p>Elring No: 015 870</p>	
<p>IVECO</p> <p>Mot 8210.22 330.30 Turbo 190.33 Turbo Star</p> <p>Full Set Gasket</p>	910 22 29	<p>190 88 81</p> <p>Elring No: 017 990</p>	

Disclaimer: OEM numbers are for reference only and do not imply that they are originals parts.



www.eurogasket.com.tr

To fit IVECO

FULL SET GASKET

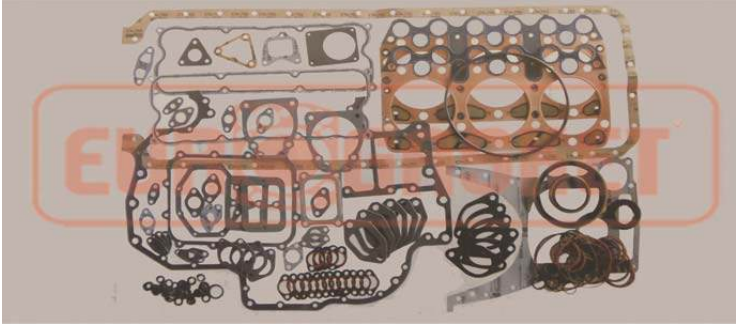
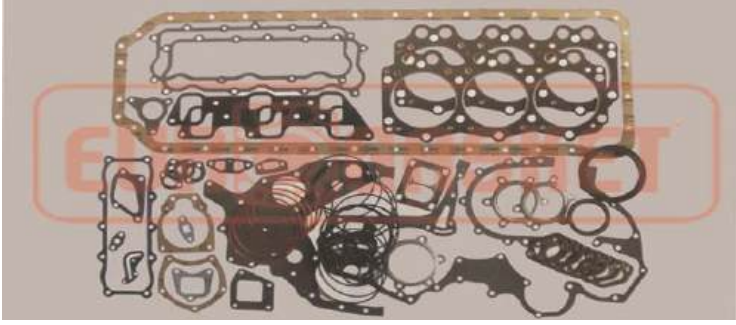
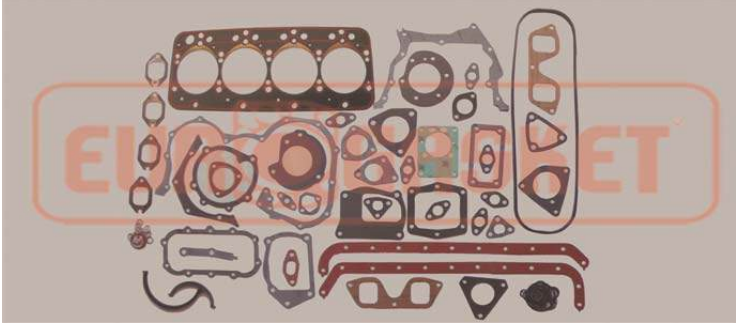
Engine Model / Description	Eurogasket Part Number	OEM Part Number	Product Picture
<p>IVECO Mot 8210.42 L.U.K Eurotech Eurostar Eurotrakker</p> <p>Full Set Gasket</p>	<p>910 24 19</p>	<p>190 86 91</p>	
<p>IVECO 175.24/190.24 TRU 190.92GV</p> <p>180E 30,34,38 TURBO 190E 30,34</p> <p>240E 38260 E37 400 E38 T/P</p> <p>Full Set Gasket 6 Cyl. Ø120</p>	<p>910 20 94</p>	<p>190 80 16</p> <p>Elring No: 013 961</p>	
<p>IVECO Mot 8040.05 50.9 – 65.9 Zeta</p> <p>Full Set Gasket</p>	<p>910 23 43</p>	<p>190 78 67</p>	

Disclaimer: OEM numbers are for reference only and do not imply that they are originals parts.



www.eurogasket.com.tr

To fit IVECO

HEAD SET GASKET

Engine Model / Description	Eurogasket Part Number	OEM Part Number	Product Picture
<p>IVECO 351 A BUS 684 N/Np MOTOR 8200.02 684 Nr/684T 690 N4/690 T4 Head Set Gasket 6 Cyl. Ø122</p>	910 2063	190 8047	
<p>IVECO 65 E12 EUROARGO Head Set Gasket 4 Cyl. Ø104</p>	910 3171	<p>190 7939 Elring No: 013 170</p>	
<p>IVECO 180E 42-190E 42-260 E42 190E 31 Hy-240 E42 Ps 440 E37 EUROTECH/EUROSTAR 440E 37 -440 E42 T/P 720 Head Set Gasket</p>	<p>910 22 92 910 24 10</p>	<p>190 88 18 190 86 90</p>	
<p>IVECO TURBO 9500CC Head Set Gasket</p>	910 2087	<p>190 8023 Elring No: 013 820</p>	
<p>IVECO Mot 8210.42-22 330.36 – 330.30 190.36 – 190.33 Turbostar Head Set Gasket</p>	910 31 40	<p>190 79 60 Elring No: 524 590</p>	

Disclaimer: OEM numbers are for reference only and do not imply that they are originals parts.



www.eurogasket.com.tr

To fit IVECO

CYLINDER HEAD GASKET

Engine Model / Description	Eurogasket Part Number	OEM Part Number	Product Picture
<p>IVECO</p> <p>170.35 170 Nc 35 190 Nc 33 220.35 260 Pc260.35 330 Pc/Pt V MOTOR 8280.02 380.35</p> <p>Cylinder Head Gasket Ø145</p>	624 8597	486 2513	
<p>IVECO</p> <p>65 E12 EUROARGO Cylinder Head Gasket 4 Cyl. Ø104</p>	910 3275	190 78 35	
<p>IVECO 3455 CC Cylinder Head Gasket 6 Cyl. Ø 100</p>	910 32 78	190 78 32 Elring No: 835 547	
<p>IVECO</p> <p>302 BUS – 303 BUS</p> <p>306 BUS 405-410-411 682 N3-682 N4-682 T3 682 T4 690 N1-690 N2-690T1</p> <p>Cylinder Head Gasket 3 Cyl. Ø130 x 145</p>	624 2633	486 8477 Elring No: 894 516	
<p>IVECO</p> <p>159 Nt-160 Nc-160 Nt 4678902 160R 308L-343R-343 T 418A 418 Ac-418 AL Mot.8200.03 684 T9.2 TON 10308cc</p> <p>Cylinder Head Gasket 3 Cyl. Ø125</p>	624 2630	486 8470 Elring No: 894 532	

Disclaimer: OEM numbers are for reference only and do not imply that they are originals parts.



www.eurogasket.com.tr

To fit IVECO

CYLINDER HEAD GASKET

Engine Model / Description	Eurogasket Part Number	OEM Part Number	Product Picture
<p>IVECO 351 A BUS 684 N/Np MOTOR 8200.02 684 Nr/684T 690 N4/690 T4 Cylinder Head Gasket 3 Cyl. Ø122</p>	645 1964	465 9146	
<p>IVECO 180E 42-190E 42-260 E42 190E 31 Hy-240 E42 Ps 440 E37 EUROTECH/EUROSTAR 440E 37 -440 E42 T/P 720 Cylinder Head Gasket</p>	116 45395	994 65715	
<p>IVECO Mot 8200.02 684 N.T Cylinder Head Gasket 3 Cyl.</p>	64 51 964	46 59 146	
<p>IVECO Mot 8210.02 697 N Cylinder Head Gasket 3 Cyl.</p>	6365 102	4745 908 Elring No: 916 110	
<p>IVECO Mot 8210.42 L.U.K Eurotech 180-190-240-E42 Eurostar 260-400-440 E42 Eurotrækker 190-380-720 Cylinder Head Gasket 3 Cyl.</p>	1164 0643	9946 0467 Elring No: 704 310	

Disclaimer: OEM numbers are for reference only and do not imply that they are originals parts.



www.eurogasket.com.tr

To fit IVECO

CYLINDER HEAD GASKET

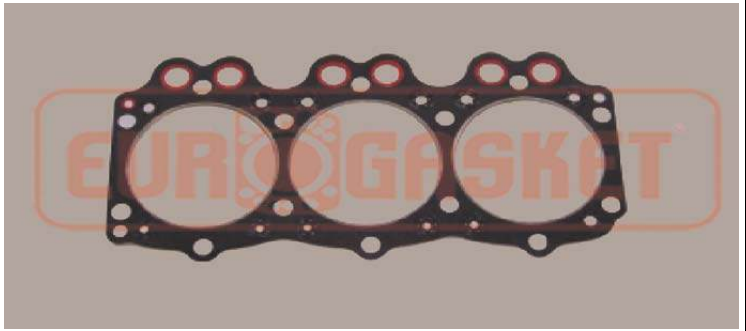
Engine Model / Description	Eurogasket Part Number	OEM Part Number	Product Picture
<p>IVECO 170.30-t-190 36-330.36 190.30 H-220.30-240.30-330.30 190.33/190.36 Ts BUS 370.30 Cylinder Head Gasket 3 Cyl. Ø137</p>	<p>1162 6756</p>	<p>9948 4354 Elring No: 704 300</p>	
<p>IVECO 175.24/190.24 TRU 190.92GV 180E 30,34,38 TURBO 190E 30,34 240E 38260 E37 400 E38 T/P Cylinder Head Gasket 3 Cyl. Ø120</p>	<p>497 91025</p>	<p>613 19085 Elring No: 776 395</p>	

Disclaimer: OEM numbers are for reference only and do not imply that they are originals parts.



www.eurogasket.com.tr

To fit IVECO

OIL PAN GASKET

Engine Model / Description	Eurogasket Part Number	OEM Part Number	Product Picture
IVECO Mot 8200.02 684 N-T Oil Pan Gasket	65 72 200	45 38 800	
IVECO Mot 8210.02 697 N Oil Pan Gasket	631 96 84	479 14 26 Elring No: 583 790	
IVECO Mot 8060.25 R-U Mot 8060.45 B-L-M Oil Pan Gasket	910 32 99	190 78 11 Elring No: 583 620	
IVECO Mot 8210.22 - 42 Oil Pan Gasket	631 96 84	479 14 26 Elring No: 583 790	
IVECO Mot 8460.21 B-R Mot 8460.41 T-C-A Oil Pan Gasket	497 80 886	613 20 224	

Disclaimer: OEM numbers are for reference only and do not imply that they are originals parts.



www.eurogasket.com.tr

To fit IVECO

INTAKE MANIFOLD GASKET

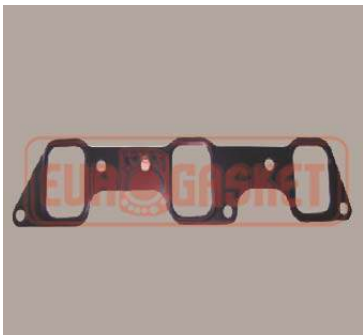
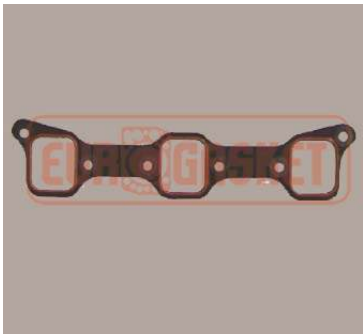
Product Details		Product Picture	
<p>IVECO Mot 8210.42 L-U-K Eurotech – Eurostar Eurotrakker</p> <p>Intake Manifold Gasket</p> <p>OEM No: 994 40 847</p> <p>Eurogasket No: 116 60 263</p>		<p>IVECO Mot 8460.21 B-R Mot 8460.41 F-C-A</p> <p>Intake Manifold Gasket</p> <p>OEM No: 613 21 089</p> <p>Eurogasket No: 497 89 021</p>	
<p>IVECO Mot 8210.22 / 42 Turbostar</p> <p>Intake Manifold Gasket</p> <p>OEM No: 99 444 980</p> <p>Eurogasket No: 11 666 120</p>			

Disclaimer: OEM numbers are for reference only and do not imply that they are originals parts.



www.eurogasket.com.tr

To fit IVECO

EXHAUST MANIFOLD GASKET

Product Details		Product Picture	
<p>IVECO Mot 8210 – 22 / 42 Turbostar</p> <p>Exhaust Manifold Gasket</p> <p>OEM No: 48 39 530</p> <p>Eurogasket No: 62 71 570</p>		<p>IVECO Mot 8460.21 B-R Mot 8460.41 T-C-A Exhaust Manifold Gasket</p> <p>OEM No: 613 19 208</p> <p>Eurogasket No: 497 91 802</p> <p>Elring No: 704 080</p>	
<p>IVECO Mot 8210.42 L-U-K Eurotech – Eurostar Eurotrakker</p> <p>Exhaust Manifold Gasket</p> <p>OEM No: 984 09 494</p> <p>Eurogasket No: 126 01 616</p>			

Disclaimer: OEM numbers are for reference only and do not imply that they are originals parts.



www.eurogasket.com.tr

SEALS – To Fit IVECO



OEM Part Number	DPH Part Number	Elring Part Number	Corteco Part Number	Application	Dimensions
112 2949	47952		01002259	Front Axle	10 x 15 x 3 NBR
126 8104	17907		12011143	Crankshaft	35 x 47 x 7 NBR
127 4257	81637		12011331	Gear Box	48 x 65 x 10 NBR
128 8064	17448		12011112	Crankshaft	17 x 28 x 7 NBR
129 0380	20004		01025734	Crankshaft	38 x 52 x 7 NBR
190 5085	96979		12012235	Crankshaft	95,30 x 114,29 x 11,88 FPM
244 2744	61249		12011423	Crankshaft	150 x 170 x 15 NBR
247 5845	94932	105457	12012064	Crankshaft	120 x 140 x 13 NBR
247 5900	111637		12012065	Crankshaft	110 x 130 x 13 NBR
247 5977	113977		12018944	Wheel Hub	117,48 x 152,36 x 22 NBR
247 7868	42696		12011360	Crankshaft	85 x 110 x 12 NBR
247 8478	93695		12011383	Crankshaft	55 x 68 x 12 NBR
247 9330	93222			Crankshaft	120,65 x 160,35 x 30,56 NBR
247 9949	84679			Axle	111,12 x 146,05 x 24,21 NBR
298 0071	81637		12011331	Gear Box	48 x 65 x 10 NBR
298 2310	17615		12011123	Crankshaft	25 x 40 x 7 NBR
299 7032	114876			Crankshaft	150 x 170 x 12 NBR
3 345 907	18234		12011168	Crankshaft	45 x 65 x 10 NBR
3 345 908	114453			Crankshaft	110 x 140 x 14 NBR
3 414 237	114433			Crankshaft	135 x 160 x 13 NBR
3850 5699	4306	546038	12011026	Front-Rear Axle	80 x 100 x 10 NBR
3851 0549	84535	530107	12011021	Wheel Hub	75 x 100 x 10 NBR
3851 2262	18698		12011030	Crankshaft	80 x 110 x 12 NBR
3851 4100	84533	325473	12011017	Crankshaft	70 x 100 x 12 NBR
4000 0010	82398		12011460	Crankshaft	42 x 65 x 12/8 ACM
4000 0050	48470	325007	12011455	Crankshaft	40 x 56 x 7 ACM
4000 0280	81351		12011433	Crankshaft	62 x 80 x 10 ACM
4000 0283	81351	028436	12011433	Crankshaft	62 x 80 x 10 ACM
4000 0370	51487		12001744	Gear Box	45 x 65 x 10 NBR
4000 0480	18949		12011373	Wheel Hub	145 x 170 x 13 NBR
4000 0520	50343			Gear Box	55 x 80 x 10 NBR
4000 0583	81352		12011459	Crankshaft	42 x 62 x 10 ACM
4000 0690	70805		12011379	Crankshaft	180 x 200 x 15 NBR
4000 0720	82399	071570	12011314	Crankshaft	95 x 120 x 13 FPM
4000 0760	111681		12011363	Crankshaft	100 x 120 x 10 NBR
4000 1010	81339		12011417	Wheel Hub	117,47 x 142,87 x 12,70 NBR
4000 1060	18895		12011347	Crankshaft	118 x 136 x 13 NBR

Disclaimer: OEM numbers are for reference only and do not imply that they are originals parts.



www.eurogasket.com.tr

SEALS – To Fit IVECO



OEM Part Number	DPH Part Number	Eling Part Number	Corteco Part Number	Application	Dimensions
4000 1650	18967		12011376	Crankshaft	160 x 185 x 13 NBR
4000 1653	18967		12011376	Crankshaft	160 x 185 x 13 NBR
4000 1820	70214		12010923	Crankshaft	38 x 50 x 7 NBR
4000 1830	97437		12011411	Crankshaft	75 x 100 x 13 NBR
4000 1880	97437		12011411	Gear Box	75 x 100 x 13 NBR
4000 1900	18763		12011412	Rear Axle	90 x 110 x 13 NBR
4000 1910	81335		12011415	Wheel Hub	100 x 130 x 13 NBR
4000 1913	81335		12011415	Wheel Hub	100 x 130 x 13 NBR
4000 1920	81339		12011417	Wheel Hub	117,47 x 142,87 x 12,70 NBR
4000 1930	81334		12011419	Crankshaft	125 x 150 x 13 NBR
4000 1933	81334	022560	12011419	Crankshaft	125 x 150 x 13 NBR
4000 2020	47466		12011334	Gear Box	60 x 85 x 10 NBR
4000 2631	81347			Crankshaft	90 x 115 x 13 FPM
4000 2851	114427		12011416	Wheel Hub	105 x 136 x 13 NBR
4000 3710	81345		12011432	Differential	50 x 81 x 13 ACM
4000 3713	81345		12011432	Differential	50 x 81 x 13 ACM
4000 3720	82893	348376	12011378	Crankshaft	180 x 200 x 12 NBR
4000 3730	81338	018670	12011326	Crankshaft	180 x 200 x 12 FPM
4000 3800	116149		12011318	Crankshaft	114 x 135 x 13 FPM
4010 0093	114439		12001579	Wheel Hub	95 x 114 x 14 ACM
4010 0103	114452		12011593	Crankshaft	140 x 160 x 14 ACM
4010 0110	114451		12001580	Crankshaft	100 x 130 x 14 ACM
4010 0113	114451		12001580	Crankshaft	100 x 130 x 14 ACM
4010 0310	81347		12011304	Crankshaft	90 x 115 x 13 FPM
4010 0313	81347		12011304	Crankshaft	90 x 115 x 13 FPM
4010 0393	114876			Crankshaft	150 x 170 x 12 NBR
4010 0440	82893		12012049	Crankshaft	180 x 200 x 12 NBR
4010 0443	82893		12012049	Crankshaft	180 x 200 x 12 NBR
4010 0460	81353		12014422	Crankshaft	100 x 130 x 12 ACM
4010 0463	81353		12014422	Crankshaft	100 x 130 x 12 ACM
4010 0470	83908		12014599	Wheel Hub	85 x 110 x 12 ACM
4010 0473	83908			Wheel Hub	85 x 110 x 12 ACM
4010 0480	81631		12014289	Wheel Hub	70 x 90 x 12 ACM
4010 0483	81631		12010483	Wheel Hub	70 x 90 x 12 ACM
4010 0490	114390		12013860	Crankshaft	78 x 100 x 10 FPM
4010 0650	81344		12014598	Wheel Hub	134 x 152 x 14 ACM
4010 0653	81344		12014598	Wheel Hub	134 x 152 x 14 ACM

Disclaimer: OEM numbers are for reference only and do not imply that they are originals parts.



www.eurogasket.com.tr

SEALS – To Fit IVECO



OEM Part Number	DPH Part Number	Etring Part Number	Corteco Part Number	Application	Dimensions
4010 0660	81343		12014601	Crankshaft	140 x 170 x 14 ACM
4010 0663	81343		12014601	Crankshaft	140 x 170 x 14 ACM
4010 0670	81338		12014190	Wheel Hub	180 x 200 x 12 FPM
4010 0673	81338		12014190	Wheel Hub	180 x 200 x 12 FPM
4010 0790	81348		12012768	Crankshaft	30 x 47 x 8 ACM
4010 0791	81348		12012768	Crankshaft	30 x 47 x 8 ACM
4010 0860	47995		12015770	Differential	80 x 100 x 10 FPM
4010 0870	112609		12016489	Crankshaft	42 x 65 x 10 FPM
4010 1080	4378		12014616	Gear Box	25 x 35 x 7 NBR
4010 1093	114426		12015745	Crankshaft	150 x 170 x 16 FPM
4010 1103	114431		12014302	Crankshaft	120 x 140 x 14 FPM
4010 1113	114430		12012815	Crankshaft	128 x 148 x 12 FPM
4010 1353	114440		12016835	Crankshaft	48 x 62 x 10 FPM
4010 1400	51252		12015746	Crankshaft	125 x 150 x 15 FPM
4010 1430	81349		12015780	Crankshaft	140 x 165 x 15 FPM
4010 1433	81349		12015780	Crankshaft	140 x 165 x 15 FPM
4010 1700	81355		12014381	Wheel Hub	70 x 100 x 13 ACM
4010 1730	83906		12015265	Crankshaft	180 x 200 x 17 FPM
4010 1733	83906		12015265	Crankshaft	180 x 200 x 17 FPM
4010 2050	81350		12015544	Crankshaft	85 x 110 x 14 FPM
4010 2053	81350		12015544	Crankshaft	85 x 110 x 14 FPM
4010 2103	114458		12015506	Wheel Hub	128 x 144/152,30 x 11/25 FPM
4010 2140	93221		12015509	Crankshaft	95 x 130 x 16 FPM/ACM
4010 2143	93221	454000	12015509	Crankshaft	95 x 130 x 16 FPM/ACM
4010 2263	81354		12015791	Differential	60 x 90 x 14/16,30 FPM/ACM
4010 2270	95465		12015793	Crankshaft	70 x 90 x 13,5/14,50 FPM
4010 2273	95465	013930	12015793	Crankshaft	70 x 90 x 13,5/14,50 FPM
4010 2280	114864		12014381	Wheel Hub	70 x 100 x 13,5/15 FPM
4010 2283	114864		12014381	Wheel Hub	70 x 100 x 13,5/15 FPM
4010 2290	109807		12015928	Crankshaft	65 x 90 x 13/14,50 FPM/ACM
4010 2293	109807		12015928	Crankshaft	65 x 90 x 13/14,50 FPM/ACM
4010 2301	111389		12033893	Crankshaft	80 x 110/115 x 10/13 FPM
4010 2320	111390		12017353	Crankshaft	114,10 x 152/159,30 x 14 FPM
4010 2321	111390		12017353	Crankshaft	114,10 x 152/159,30 x 14 FPM
4010 2660	81354		12015791	Differential	60 x 90 x 14/16,30 FPM/ACM
4010 2940	114855	456130	12017354	Wheel Hub	179 x 200 x 15,5/16,5 FPM
4010 2943	114855	456130	12017354	Wheel Hub	179 x 200 x 15,5/16,5 FPM

Disclaimer: OEM numbers are for reference only and do not imply that they are originals parts.



www.eurogasket.com.tr

SEALS – To Fit IVECO



OEM Part Number	DPH Part Number	Eling Part Number	Corteco Part Number	Application	Dimensions
4200 1982	96201				35 x 42 x 5,50 NBR
4203 1150	48022		12015887	Rear Axle	115 x 140 x 13 NBR
4203 7581	82893	348376	12011378	Crankshaft	180 x 200 x 12 NBR
4203 7582	113031	018670	12011326	Crankshaft	180 x 200 x 12 FPM
4206 1445	43194				65 x 80 x 8 NBR
4206 2983	114876				150 x 170 x 12 NBR
4206 2984	114426				150 x 170 x 16 FPM
4212 7773	117705		12019601	Crankshaft	180 x 200 x 13,50 NBR
4248 5827	4047	033464	12013757	Gear Box	85 x 105 x 10 FPM
4248 6609	50343			Gear Box	55 x 80 x 10 NBR
4248 7132	47991		12012578	Gear Box	60 x 85 x 12 FPM
4248 7485	81637		12011331	Gear Box	48 x 65 x 10 NBR
4249 0447	96979		12012235	Gear Box	95,30 x 114,29 x 11,88 FPM
4459 074	18484		12010997	Crankshaft	60 x 75 x 8 NBR
4460 212	81342			Rear Axle	140 x 160/190 x 14/28 NBR
4560 719	70576		12011349	Rear Axle	140 x 160 x 13 NBR
4580 400	18967		12011376	Crankshaft	160 x 185 x 13 NBR
4587 996	17780		12010889	Crankshaft	30 x 55 x 10 NBR
540 727	18701		12011031	Gear Box	80 x 110 x 13 NBR
7010 0303	81631				70 x 90 x 12 ACM
724 579	17780		12010889	Crankshaft	30 x 55 x 10 NBR
734 128	17780		12010889	Crankshaft	30 x 55 x 10 NBR
767 775	17615	038164	12011123	Steering	25 x 40 x 7 NBR
798 0285	114111		12010744	Crankshaft	47,63 x 65,07 x 6,35 FPM
798 0661	96979		12012235	Gear Box	95,30 x 114,29 x 11,88 FPM
812 3442	94056				150 x 180 x 15 NBR
819 4388	84542		11014231	Injection Pump	30 x 42 x 6/6,8 NBR
843 075	84535		12011021	Gear Box	75 x 100 x 10 NBR
851 101	84533	325473	12011017	Engine Various	70 x 100 x 12 NBR
852 7970	6713	109657	12011091	Front-Rear Axle	150 x 180 x 13 NBR
8601 4686	113957		07013389	Wheel Hub	95 x 110 x 10 NBR
883 6666	97437		12011411	Gear Box	75 x 100 x 13 NBR

Disclaimer: OEM numbers are for reference only and do not imply that they are originals parts.



to fit- MAN



www.eurogasket.com.tr

To fit MAN

FULL SET GASKET

Engine Model / Description	Eurogasket Part Number	OEM Part Number	Product Picture
MAN D 0224 Full Set Gasket Ø102	59 00100 4582	51 00900 6528	
MAN D 0226 Full Set Gasket Ø102	59 0100 4606	51 00900 6404	
MAN D 0824 Full Set Gasket Ø108	59 0100 4533	51 00900 6577 Elring No: 051 370	
MAN D 0826 Full Set Gasket Ø108	59 00100 4579	51 00900 6531 Elring No: 750 027	
MAN D 2156 Full Set Gasket Ø121	59 00100 4806	51 00900 6204	

Disclaimer: OEM numbers are for reference only and do not imply that they are originals parts.



www.eurogasket.com.tr

To fit MAN

FULL SET GASKET

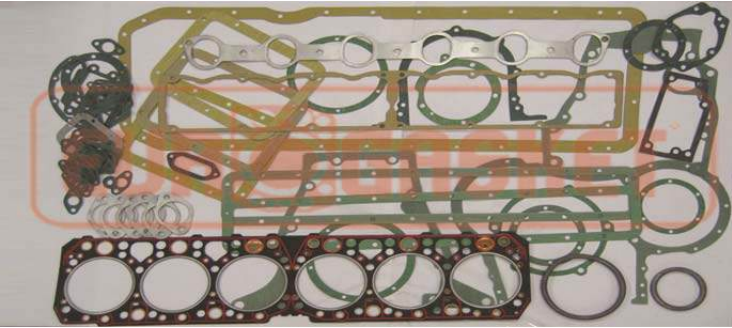
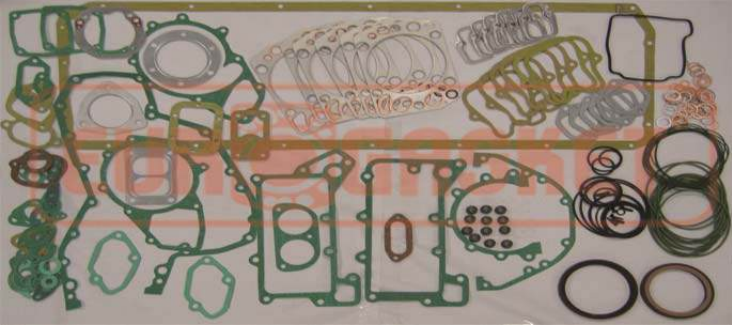
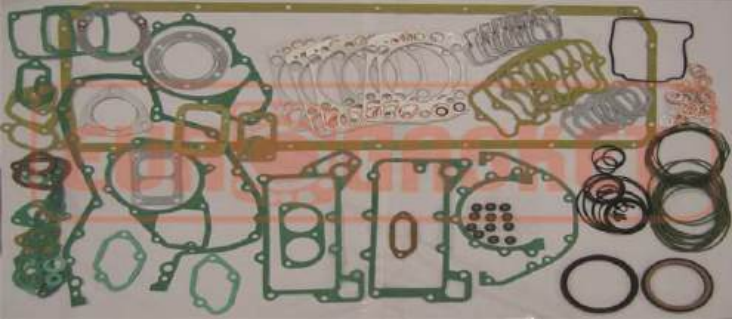
Engine Model / Description	Eurogasket Part Number	OEM Part Number	Product Picture
MAN D 2356 Full Set Gasket Ø123	59 00100 4954	51 00900 6156	
MAN D 2066 Full Set Gasket	59 00100 4420	51 00900 6680 Elring No: 198 610	
MAN 2566 Full Set Gasket Ø125 Copper Metal	59 00100 4653	51 00900 6457 Elring No: 891 224	
MAN D 2866 Full Set Gasket Ø128 Copper Metal	59 00100 4712	51 00900 6398 Elring No: 518 346	
MAN D 2866 Full Set Gasket Ø128 Rubber Metal	59 00100 4712	51 00900 6398 Elring No: 518 346	

Disclaimer: OEM numbers are for reference only and do not imply that they are originals parts.



www.eurogasket.com.tr

To fit MAN

FULL SET GASKET

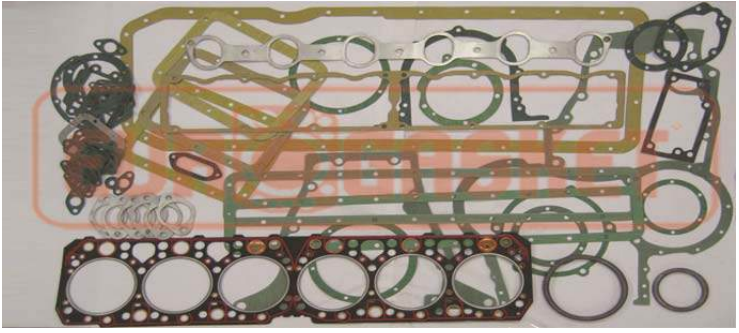
Engine Model / Description	Eurogasket Part Number	OEM Part Number	Product Picture
MAN 2876 4V Full Set Gasket	59 00100 4458	51 00900 6652 Elring No: 124 960	
MAN D 2146 HM1U MAN D 2156 HMXU IKARUS Full Set Gasket	59 00100 4985	51 00900 6125	
MAN D 2356 IKARUS Full Set Gasket Ø123 Rubber Metal Copper Metal	59 00100 4519 59 00100 4519-1	51 00900 6591	
MAN D2866 Conversion Set	59 00100 4407	51 00900 6603 Elring No: 146 350	
MAN D2566-2866 Conversion Set	59 00100 4408	51 00900 6602 Elring No: 146 340	

Disclaimer: OEM numbers are for reference only and do not imply that they are originals parts.



www.eurogasket.com.tr

To fit MAN

HEAD SET GASKET

Engine Model / Description	Eurogasket Part Number	OEM Part Number	Product Picture
MAN D 0224 – D 0226 Head Set Gasket	59 00100 4686	51 00900 6424 Elring No: 560 538	
MAN D 0824 – D 0826 Head Set Gasket	59 00100 4550	51 00900 6550 Elring No: 835 641	
MAN D 2066 Head Set Gasket	59 00100 4429	51 00900 6681 Elring No: 195 080	
MAN 2538 ME Head Set Gasket	59 00100 4481	51 00900 6629 Elring No: 215 230	
MAN 2530 MAN 2555 MAN 2566 Head Set Gasket Copper Metal	59 00100 4530	51 00900 6570 Elring No: 286 711	

Disclaimer: OEM numbers are for reference only and do not imply that they are originals parts.



www.eurogasket.com.tr

To fit MAN

HEAD SET GASKET

Engine Model / Description	Eurogasket Part Number	OEM Part Number	Product Picture
<p>MAN D 2866 Head Set Gasket Ø128 Rubber Metal</p>	<p>59 00100 4552</p>	<p>51 00900 6629 Elring No: 215 230</p>	
<p>MAN D 2866 Head Set Gasket Ø128 Copper Metal</p>	<p>59 00100 4552</p>	<p>51 00900 6558 Elring No: 834 327</p>	
<p>MAN D 2840 MAN D 2842 MAN D 2866 Head Set Gasket Ø128 Copper Metal</p>	<p>59 07109 0754</p>	<p>51 00900 6558 Elring No: 834 327</p>	
<p>MAN 2866 4V MAN 2876 4V Head Set Gasket</p>	<p>59 00100 4470</p>	<p>51 00900 6630 Elring No: 296 770</p>	
<p>MAN 2876 4V Head Set Gasket</p>	<p>59 00100 4458</p>	<p>51 00900 6652 Elring No: 124 960</p>	

Disclaimer: OEM numbers are for reference only and do not imply that they are originals parts.



www.eurogasket.com.tr

To fit MAN

CYLINDER HEAD GASKET

Engine Model / Description	Eurogasket Part Number	OEM Part Number	Product Picture
MAN D 0224 MAN D 0226 Cylinder Head Gasket Ø 102	59 07109 0824	51 03901 0286 Elring No: 518 817	
MAN D 0824 MAN D 0826 MAN D 0836 LF Cylinder Head Gasket Ø 108	59 07109 0731	51 03901 0379 Elring No: 845 710	
MAN D 2066 Cylinder Head Gasket Ø 121	59 07109 0607	51 03901 0403 Elring No: 021 262	
MAN D 2156 Cylinder Head Gasket Ø 121	59 07109 0847	51 03901 0263	
MAN D 2356 Cylinder Head Gasket Ø 123	59 07109 0846	51 03901 0264	

Disclaimer: OEM numbers are for reference only and do not imply that they are originals parts.



www.eurogasket.com.tr

To fit MAN

CYLINDER HEAD GASKET

Engine Model / Description	Eurogasket Part Number	OEM Part Number	Product Picture
<p>MAN 2530 MF MAN 2555 MAN 2556 Cylinder Head Gasket Ø 125 Copper Metal</p>	<p>59 07109 0768</p>	<p>51 03901 0342 Elring No: 834 548</p>	
<p>MAN D 2866 Cylinder Head Gasket Ø 128 Copper Metal</p>	<p>59 07109 0754</p>	<p>51 03901 0356 Elring No: 451 690</p>	
<p>MAN D 2866 Cylinder Head Gasket Ø 128 Rubber Metal</p>	<p>59 07109 0812</p>	<p>51 03901 0298 Elring No: 752 037</p>	
<p>MAN 2876 4V Cylinder Head Gasket Ø 128 Rubber Metal</p>	<p>59 07109 0772</p>	<p>51 03901 0338 Elring No: 829 722</p>	
<p>MAN D 2146 HM1U MAN D 2156 HMXU IKARUS Cylinder Head Gasket</p>	<p>59 07109 0840</p>	<p>51 03901 0260</p>	

Disclaimer: OEM numbers are for reference only and do not imply that they are originals parts.



www.eurogasket.com.tr

To fit MAN

OIL PAN GASKET

Engine Model / Description	Eurogasket Part Number	OEM Part Number	Product Picture
<p>MAN D 0224 MAN D 0824 Oil Pan Gasket</p>	<p>59 05106 0939</p>	<p>51 05904 0171 Elring No: 834 697</p>	
<p>MAN D 0226 MAN D 0826 Oil Pan Gasket</p>	<p>59 05106 0971</p>	<p>51 05904 0139 Elring No: 895 319</p>	
<p>MAN D 2066 Oil Pan Gasket (Rubber)</p>	<p>59 05106 0898</p>	<p>51 05904 0212 Elring No: 357 570</p>	
<p>MAN D 2066 Oil Pan Gasket</p>	<p>59 05106 0806</p>	<p>51 05904 0204 Elring No: 492 520</p>	
<p>MAN D 2156 – 2356 Oil Pan Gasket MAN IKARUS Oil Pan Gasket</p>	<p>59 0106 0096 59 0106 0096</p>	<p>51 05904 0101 51 0904 0014</p>	

Disclaimer: OEM numbers are for reference only and do not imply that they are originals parts.



www.eurogasket.com.tr

To fit MAN

OIL PAN GASKET

Engine Model / Description	Eurogasket Part Number	OEM Part Number	Product Picture
MAN D 2566 MAN D 2866 Oil Pan Gasket 6 Cyl.	59 05106 0978	51 05904 0132 Elring No: 921 084	
MAN D 2566 MAN D 2866 Oil Pan Gasket 4 PCS	59 05106 0978-1	51 05904 0132	
MAN D 2555 – 2565 - 2865 Oil Pan Gasket 5 Cyl.	59 05106 0979	51 05904 0131 Elring No: 775 330	
MAN D 2876 Oil Pan Gasket (Rubber)	59 05106 0921 59 05106 0912	51 05904 0189 51 05904 0198 Elring No: 845 541	

Disclaimer: OEM numbers are for reference only and do not imply that they are originals parts.



www.eurogasket.com.tr

To fit **MAN**

VALVE COVER GASKET

Product Details		Product Picture	
<p>MAN D 0226 MAN D 0826 Valve Cover Gasket (Metal) OEM No: 51 03905 0155</p> <p>Eurogasket No: 59 07105 0955</p> <p>Elring No: 636 310</p>		<p>MAN D 0226 MAN D 0826 Valve Cover Gasket</p> <p>OEM No: 51 03905 0148</p> <p>Eurogasket No: 59 07105 0962</p> <p>Elring No: 835 634</p>	
<p>MAN D 2066 Valve Cover Gasket</p> <p>OEM No: 51 03905 0177</p> <p>Eurogasket No: 59 07105 0933</p> <p>Elring No: 136 980</p>		<p>MAN D 2156 - 2356 Valve Cover Gasket</p> <p>OEM No: 51 03905 0099</p> <p>Eurogasket No: 59 07105 0011</p>	
<p>MAN D 2566 MAN D 2866 Valve Cover Gasket</p> <p>OEM No: 51 03905 0135</p> <p>Eurogasket No: 59 07105 0975</p> <p>Elring No: 829 803</p>		<p>MAN D 2566 MAN D 2866 Valve Cover Gasket (Siliconed)</p> <p>OEM No: 51 03905 0135</p> <p>Eurogasket No: 59 07105 0975</p>	
<p>MAN D 2866 4V MAN D 2876 4V Valve Cover Gasket</p> <p>OEM No: 51 03905 0157</p> <p>Eurogasket No: 59 07105 0953</p> <p>Elring No: 123 410</p>			

Disclaimer: OEM numbers are for reference only and do not imply that they are originals parts.



www.eurogasket.com.tr

To fit **MAN**

INTAKE MANIFOLD GASKET

Product Details		Product Picture	
<p>MAN D 0226 MAN D 0826 Intake Manifold Gasket</p> <p>OEM No: 51 08902 0121 51 08902 0179</p> <p>Eurogasket No: 59 02108 0989</p>		<p>MAN D 2156 MAN D 2366 Intake Manifold Gasket</p> <p>OEM No: 51 08902 0006</p> <p>Eurogasket No: 59 02108 0004</p>	
<p>MAN D 2566 MAN D 2866 Intake Manifold Gasket</p> <p>OEM No: 51 08902 0161</p> <p>Eurogasket No: 59 02108 0949</p> <p>Elring No: 896 365</p>		<p>MAN D 2876 4V Intake Manifold Gasket</p> <p>OEM No: 51 08902 0155</p> <p>Eurogasket No: 59 02108 0955</p>	

Disclaimer: OEM numbers are for reference only and do not imply that they are originals parts.



www.eurogasket.com.tr

To fit **MAN**

EXHAUST MANIFOLD GASKET

Product Details	Product Picture	Product Details	Product Picture
<p>MAN D 0226 MAN D 0826 Exhaust Manifold Gasket</p> <p>OEM No: 51 08901 0027</p> <p>Eurogasket No: 59 02109 0083</p> <p>Elring No: 277 762</p>		<p>MAN D 2066 Exhaust Manifold Gasket</p> <p>OEM No: 51 08901 0170</p> <p>Eurogasket No: 59 02109 0930</p> <p>Elring No: 008 763</p>	
<p>MAN D 2066 Exhaust Manifold Gasket</p> <p>OEM No: 51 08901 0206</p> <p>Eurogasket No: 59 02109 0804</p>		<p>MAN D 2066 Exhaust Manifold Ring</p> <p>OEM No: 51 98701 0120</p> <p>Eurogasket No: 59 12309 0980</p>	
<p>MAN D 2156 MAN D 2366 Exhaust Manifold Gasket</p> <p>OEM No: 51 98701 0068</p> <p>Eurogasket No: 59 12309 0042</p>		<p>MAN D 2566 MAN D 2866 Exhaust Manifold Gasket</p> <p>OEM No: 51 08901 0023</p> <p>Eurogasket No: 59 02109 0087</p> <p>Elring No: 638 951</p>	
<p>MAN D 2866 MAN D 2876 Exhaust Manifold Gasket</p> <p>OEM No: 51 08901 0152 51 08901 0155</p> <p>Eurogasket No: 59 02109 0958</p> <p>Elring No: 762 940</p>			





Disclaimer: OEM numbers are for reference only and do not imply that they are originals parts.



www.eurogasket.com.tr

To fit **MAN**

TURBO GASKET

Product Details		Product Picture	
<p>MAN Turbo Gasket</p> <p>OEM No: 51 08901 0150</p> <p>Eurogasket No: 59 02109 0950</p> <p>Elring No: 321 541</p>		<p>MAN TGA Turbo Gasket</p> <p>OEM No: 51 15901 0012</p> <p>Eurogasket No: 59 95109 0098</p> <p>Elring No: 830 748</p>	
<p>MAN 2066 Turbo Gasket</p> <p>OEM No: 51 08901 0209-1</p> <p>Eurogasket No: 59 02109 0801-9</p>		<p>MAN 2066 Turbo Gasket</p> <p>OEM No: 51 08901 0182</p> <p>Eurogasket No: 59 02109 0928</p> <p>Elring No: 139 090</p>	
<p>MAN 2066 Turbo Gasket</p> <p>OEM No: 51 08901 0209</p> <p>Eurogasket No: 59 02109 0801</p>			





Disclaimer: OEM numbers are for reference only and do not imply that they are originals parts.

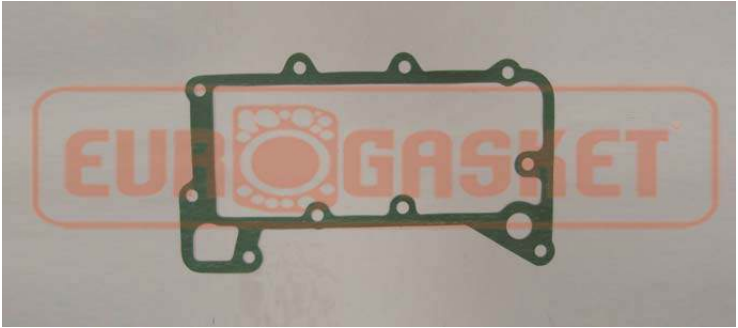

www.eurogasket.com.tr

To fit MAN

GASKET

Engine Model / Description	Eurogasket Part Number	OEM Part Number	Product Picture
MAN 2566 MAN 2866 Oil Cooler Gasket	59 05109 0991	51 05901 0119 Elring No: 803 820	
MAN 2566 MAN 2866 Water Pump Gasket	59 04109 0963	51 06901 0147 Elring No: 756 882	
MAN 2565 MAN 2866 Flywheel Gasket	59 09107 0858	51 01903 0252 Elring No: 829 595	
MAN 2530 – 2538 – 2540 – 2542 – 2555 – 2556 – 2565 – 2566 – 2840 – 2842 – 2865 – 2866 – 2876 Block Cover Gasket	59 09107 0859	51 01903 0251 Elring No: 834 556	
MAN 2866 4V MAN 2876 4V Oil Cooler Gasket	59 05109 0988	51 05901 0122 Elring No: 012 300	





Disclaimer: OEM numbers are for reference only and do not imply that they are originals parts.

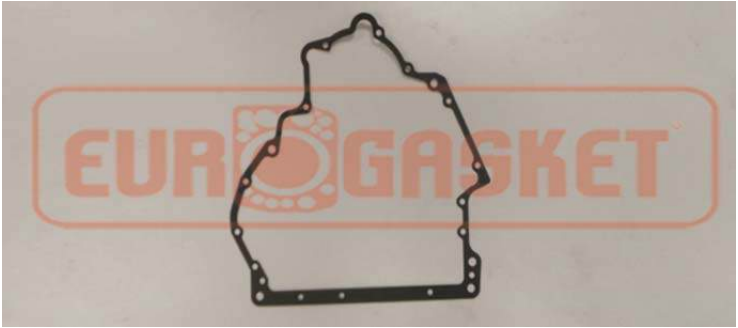

www.eurogasket.com.tr

To fit MAN

GASKET

Engine Model / Description	Eurogasket Part Number	OEM Part Number	Product Picture
MAN 2066 Timing Case Cover Gasket	59 09105 0018	51 01905 0092 Elring No: 021 431	
MAN 2066 Gasket	59 05109 0973	51 05901 0137	
MAN 2066 Thermostat Gasket	59 04106 0068	51 06904 0042 Elring No: 021 410	
MAN 2066 Water Pump Gasket	59 04109 0918	51 06901 0192 Elring No: 021 250	
MAN 2066 Water Pump Gasket	59 04107 0049	51 06903 0061 Elring No: 019 690	

Disclaimer: OEM numbers are for reference only and do not imply that they are originals parts.



www.eurogasket.com.tr

To fit MAN

GASKET

Engine Model / Description	Eurogasket Part Number	OEM Part Number	Product Picture
MAN 2066 Thermostat Gasket	59 04106 0071	51 06904 0039 Elring No: 021 380	
MAN 2066 Gasket	59 02109 0915	51 08901 0195 Elring No: 058 360	
MAN 2066 Gasket	59 02109 0938	51 08901 0172 Elring No: 008 790	
MAN 2066 Gasket	59 02109 0936	51 08901 0174 Elring No: 021 370	
MAN 2066 Copper Washer	59 12309 0971	51 98701 0139	

Disclaimer: OEM numbers are for reference only and do not imply that they are originals parts.



www.eurogasket.com.tr

To fit **MAN**

GASKET

Engine Model / Description	Eurogasket Part Number	OEM Part Number	Product Picture
MAN 2066 Gasket	59 02109 0980	51 08901 0120 Elring No: 747 050	
MAN 2066 Gasket	104 409 0334	906 601 0776	

Disclaimer: OEM numbers are for reference only and do not imply that they are originals parts.



www.eurogasket.com.tr

To fit **MAN**

SHIM

Product Details		Product Picture	
MAN Shim OEM No: 51 01222 0001 Eurogasket No: 59 09888 0009 Elring No: 703 060		MAN Shim OEM No: 51 01222 0002 Eurogasket No: 59 09888 0008 Elring No: 703 079	

Disclaimer: OEM numbers are for reference only and do not imply that they are originals parts.



www.eurogasket.com.tr

To fit MAN

RUBBER

Product Details	Product Picture	Product Details	Product Picture
<p>MAN Rubber</p> <p>OEM No: 51 96501 0263</p> <p>Eurogasket No: 59 14509 0847</p> <p>140 x 4 NBR Black</p>		<p>MAN Rubber</p> <p>OEM No: 51 96501 0338</p> <p>Eurogasket No: 59 14509 0772</p> <p>138 x 2,10 FPM Green</p>	
<p>MAN Rubber</p> <p>OEM No: 51 96501 0346</p> <p>Eurogasket No: 59 14509 0764</p> <p>138 x 3,5 FPM Gren</p> <p>Etring No: 106 607</p>		<p>MAN Rubber Set</p> <p>OEM No: 125 mm</p> <p>Eurogasket No: 26452</p> <p>2 Pcs 140 x 4 FPM Green 2 Pcs 138 x 2,1 FPM Black</p>	
<p>MAN Rubber Set</p> <p>OEM No: 125 mm</p> <p>Eurogasket No: 12812</p> <p>12 Pcs 138 x 2,1 FPM Black 12 Pcs 138 x 4 FPM Gren For 6 Cyl.</p>		<p>MAN Rubber Set</p> <p>OEM No: 125 mm</p> <p>Eurogasket No: 13161</p> <p>2 Pcs 140 x 4 FPM Green 2 Pcs 138 x 2,1 FPM Green</p>	
<p>MAN Rubber Set</p> <p>OEM No: 128 mm</p> <p>Eurogasket No: 50263</p> <p>2 Pcs 144 x 4 FPM Green 2 Pcs 138 x 2,1 FPM Black</p>		<p>MAN Rubber Set</p> <p>OEM No: 128 mm</p> <p>Eurogasket No: 906993</p> <p>12 Pcs 138 x 2,1 FPM Black 12 Pcs 144 x 4 FPM Gren For 6 Cyl.</p>	
<p>MAN Rubber Set</p> <p>OEM No: 128 mm</p> <p>Eurogasket No: 13150</p> <p>2 Pcs 144 x 4 FPM Green 2 Pcs 138 x 2,1 FPM Green</p>			

Disclaimer: OEM numbers are for reference only and do not imply that they are originals parts.



www.eurogasket.com.tr

SEALS – To Fit MAN



OEM Part Number	DPH Part Number	Eling Part Number	Corteco Part Number	Application	Dimensions
06 56260 1106	17447	050300	12010807	Crankshaft	17 x 28 x 7 NBR
06 56260 1408	17567	037850	12010838	Crankshaft	22 x 40 x 10 NBR
06 56260 1911	113776	201006	12010879	Crankshaft	30 x 40 x 7 NBR
06 56260 1912	17728	203408	12010880	Crankshaft	30 x 42 x 7 NBR
06 56261 0804	19033	037109			14 x 24 x 7 NBR
06 56261 1207	19149				18 x 30 x 7 NBR
06 56261 1609	4378	038083	12014616	Gear Box	25 x 35 x 7 NBR
06 56261 1615	17653	038385	01002458	Crankshaft	25 x 52 x 7 NBR
06 56261 1911	6451	038814		Crankshaft	30 x 40 x 7 NBR
06 56269 0001	17357				10 x 19 x 7 NBR
06 56269 0458	17672		12010870	Crankshaft	27 x 37 x 7 NBR
06 56269 0479	47952	010804	01002259	Front Axle	10 x 15 x 3 NBR
06 56269 0527	47952	010804	01002259	Front Axle	10 x 15 x 3 NBR
06 56269 0578	19212		12001989	Crankshaft	20 x 28 x 6 NBR
06 56271 0404	18076		12010932	Crankshaft	40 x 55 x 7 NBR
06 56271 0406	20011				40 x 62 x 7 NBR
06 56271 0807	18316	041114		Wheel Hub	50 x 65 x 8 NBR
06 56271 1613	18567				65 x 85 x 10 NBR
06 56271 1616	18589				65 x 100 x 10 NBR
06 56271 2015	18656				75 x 95 x 10 NBR
06 56271 3814	18612			Gear Box	70 x 90 x 10 NBR
06 56272 0047	35095	091901		Differential	52 x 72 x 12 NBR
06 56272 1212	18474				58 x 80 x 10 NBR
06 56272 1312	51483	041513		Front Axle	60 x 80 x 10 NBR
06 56272 1313	47466		12011334	Gear Box	60 x 85 x 10 NBR
06 56272 1613	18571				65 x 85 x 12 NBR
06 56272 1614	18578				65 x 90 x 12 NBR
06 56272 1714	24236				68 x 90 x 12 NBR
06 56272 1814	18616		12011410	Wheel Hub	70 x 90 x 12 NBR
06 56272 1816	18630			Crankshaft	70 x 100 x 12 NBR
06 56272 2016	18668				75 x 100 x 12 NBR
06 56272 8016	84438			Rear Axle	75 x 100 x 12 FPM
06 56274 1714	20037				68 x 90 x 10 NBR
06 56279 0003	51487	040843	12011509	Gear Box	45 x 65 x 10 NBR
06 56279 0014	18183				42 x 65 x 10 NBR
06 56279 0019	18619	042161			70 x 90 x 13 NBR
06 56279 0025	48052	008664	01020674	Front Axle	57 x 75 x 7,5/6 NBR

Disclaimer: OEM numbers are for reference only and do not imply that they are originals parts.



www.eurogasket.com.tr

SEALS – To Fit MAN



OEM Part Number	DPH Part Number	Eling Part Number	Corteco Part Number	Application	Dimensions
06 56279 0028	4767	008559	12012573	Front-Rear Axle	72 x 105 x 13 NBR
06 56279 0029	61496	108642	01020675	Front Axle	50 x 70 x 8 NBR
06 56279 0031	59295	008028	01016768	Front Axle	50 x 70 x 10/14 NBR
06 56279 0035	18175	040355	12010946	Wheel Hub	42 x 62 x 10 NBR
06 56279 0039	18223	367206	12010954	Crankshaft	45 x 62 x 10 NBR
06 56279 0041	35113				46 x 62 x 12 NBR
06 56279 0042	81637	040991	12011331	Gear Box	48 x 65 x 10 NBR
06 56279 0047	35095	091901		Differential	52 x 72 x 12 NBR
06 56279 0049	45537				55 x 72 x 10 NBR
06 56279 0050	18440				55 x 80 x 13 NBR
06 56279 0054	18499				60 x 80 x 13 NBR
06 56279 0055	35120				60 x 80 x 10 NBR
06 56279 0057	35122			Rear Axle	62 x 75 x 10 NBR
06 56279 0059	18534				62 x 85 x 10 NBR
06 56279 0064	114383		01029728	Crankshaft	70 x 90 x 10/14 NBR
06 56279 0066	18623				70 x 95 x 13 NBR
06 56279 0073	48048	008745	12014743	Front Axle	72 x 105 x 13 FPM
06 56279 0080	59295	008028		Front Axle	50 x 70 x 10/14 NBR
06 56279 0084	4545	033472	12011307	Gear Box	48 x 75 x 8 FPM
06 56279 0087	18282				48 x 62 x 10 NBR
06 56279 0095	48010			Front Axle	42 x 55 x 9 FPM
06 56279 0114	37347	010197		Rear Axle	42 x 58 x 7 NBR
06 56279 0133	37347	010197		Rear Axle	42 x 58 x 7 NBR
06 56279 0136	50343	446602		Gear Box	55 x 80 x 10 NBR
06 56279 0138	116340	041114	01020676	Wheel Hub	50 x 65 x 10 NBR
06 56279 0147	51708	484300	12003292	Front Axle	62 x 80 x 10 NBR
06 56279 0148	32721				62 x 80 x 10 FPM
06 56279 0181	61497	008591	01016769	Front Axle	64 x 80 x 13 NBR
06 56279 0183	50347	008370	01019460	Camshaft	75 x 95 x 12,50 NBR
06 56279 0184	50346	008303	01026650	Rear Axle	68 x 90 x 12,50 NBR
06 56279 0194	80530			Crankshaft	55 x 80 x 10/12 NBR
06 56279 0209	47989	008508		Rear Axle	68 x 90 x 10/9,50 FPM
06 56279 0211	114382		12013363	Gear Box	70 x 90 x 10 FPM
06 56279 0215	4380	327363	01019459	Transfer Gear Box	
06 56279 0235	104422				60 x 80 x 10 NBR
06 56279 0236	94302		01012087	Crankshaft	70 x 90 x 12 FPM
06 56279 0259	114851				131 x 75,40 x 16 NBR

Disclaimer: OEM numbers are for reference only and do not imply that they are originals parts.



www.eurogasket.com.tr

SEALS – To Fit MAN



OEM Part Number	DPH Part Number	Elring Part Number	Corteco Part Number	Application	Dimensions
06 56279 0262	97353		01030090	Camshaft	42 x 52 x 5 FPM
06 56279 0273	22997			Stub Axle	50 x 58 x 4 NBR
06 56279 0275	114372		01016915	Crankshaft	66,67 x 115,92/125,4 x 11,9/18,2
06 56279 0278	48498		01025733	Crankshaft	45 x 52 x 4 NBR
06 56279 0284	95827			Stub Axle	37,5 x 45 x 4 NBR
06 56279 0289	95828			Stub Axle	42 x 49 x 4 NBR
06 56279 0290	95957			Front Axle	35 x 42 x 4 NBR
06 56279 0291	95957			Front Axle	35 x 42 x 4 NBR
06 56279 0292	95957			Front Axle	35 x 42 x 4 NBR
06 56279 0297	48010		01017009	Front Axle	42 x 55 x 9 FPM
06 56279 0310	19600			Camshaft	42 x 58 x 7 NBR
06 56279 0312	4767	008559	12012573	Front-Rear Axle	72 x 105 x 13 NBR
06 56279 0315	113668		01019465	Crankshaft	76 x 94 x 9 NBR
06 56279 0323	47989		12012575	Differential	68 x 90 x 10/9,50 FPM
06 56279 0327	95922		01020465	Differential	68 x 90 x 10 NBR
06 56279 0331	47938	104310	01016962	Differential	75 x 95 x 10 FPM
06 56279 0335	114110	104320	01020042	Differential	75 x 95 x 9,5/10 NBR
06 56279 0341	113837			Wheel Hub	113 x 140 x 12 ACM
06 56279 0350	37347			Brake Camshaft	42 x 58 x 7 NBR
06 56279 0352	97403		12015711	Camshaft	55 x 68 x 8 FPM
06 56279 0353	22997		01012190	Stub Axle	50 x 58 x 4 NBR
06 56279 0366	48048		12014743	Differential	72 x 105 x 13 FPM
06 56281 0605	19869	519243		Front-Rear Axle	100 x 130 x 13 NBR
06 56282 0906	18888				115 x 140 x 15 NBR
06 56282 1007	48002			Front Axle	120 x 150 x 15/12 NBR
06 56282 1409	81343		12001584	Crankshaft	140 x 170 x 14 ACM
06 56282 1813	18979				170 x 200 x 15 NBR
06 56282 2015	93619			Axle	190 x 220 x 15 NBR
06 56289 0009	50810		12011401	Rear Axle	100 x 125 x 13/10 NBR
06 56289 0013	4374		12011096	Front-Rear Axle	165 x 190 x 13 NBR
06 56289 0022	50348	008354		Rear Axle	80 x 100 x 12 NBR
06 56289 0027	4376		12011374	Rear Axle	145 x 175 x 14 NBR
06 56289 0028	109292				80 x 110 x 13 FPM
06 56289 0031	81545				80 x 105 x 15 NBR
06 56289 0033	32425	096067	12011359	Differential	85 x 105 x 13 NBR
06 56289 0035	18863		12012065	Rear Axle	110 x 130 x 13 NBR
06 56289 0037	51724	518166	12003473	Front Axle	115 x 140 x 13 NBR

Disclaimer: OEM numbers are for reference only and do not imply that they are originals parts.



www.eurogasket.com.tr

SEALS – To Fit MAN



OEM Part Number	DPH Part Number	Elring Part Number	Corteco Part Number	Application	Dimensions
06 56289 0038	81334	635600	12011419	Crankshaft	125 x 150 x 13 NBR
06 56289 0039	50339			Rear Axle	135 x 165 x 13/10 NBR
06 56289 0040	19960			Front-Rear Axle	145 x 165 x 13 NBR
06 56289 0041	18951		01003537	Crankshaft	145 x 170 x 15 NBR
06 56289 0045	82397			Front-Rear Axle	175 x 200 x 15 NBR
06 56289 0046	19924				190 x 220 x 15 NBR
06 56289 0047	36789	008680		Differential	85 x 105 x 13 FPM
06 56289 0048	36789	008680	12012549	Rear Axle	85 x 105 x 13 FPM
06 56289 0050	94701	008672	01019887	Front Axle	160 x 180 x 10 NBR
06 56289 0052	94702		01019888	Front Axle	160 x 180 x 10 NBR
06 56289 0063	82427		12011407	Rear Axle	145 x 175 x 13 NBR
06 56289 0064	4376		12011374	Rear Axle	145 x 175 x 14 NBR
06 56289 0065	82427		12011407	Rear Axle	145 x 175 x 13 NBR
06 56289 0066	34644	033146		Rear Axle	145 x 175 x 13 FPM
06 56289 0067	82528	033464	12013757	Gear Box	85 x 105 x 10 FPM
06 56289 0111	51723	042684	12011398	Rear Axle	95 x 120 x 13 NBR
06 56289 0113	18846	042846	12011403	Front Axle	105 x 130 x 13 NBR
06 56289 0115	61249		12011423	Crankshaft	150 x 170 x 15 NBR
06 56289 0132	50341	556807	12011340	Gear Box	85 x 105 x 10 NBR
06 56289 0139	94728			Crankshaft	90 x 110 x 15 FPM
06 56289 0143	18976		01003567	Crankshaft	170 x 190 x 15 NBR
06 56289 0145	34644	033146		Rear Axle	145 x 175 x 13 FPM
06 56289 0167	32425	096067	12011359	Gear Box	85 x 105 x 13 NBR
06 56289 0179	50348		01017034	Crankshaft	80 x 100 x 12 NBR
06 56289 0181	51710		01017033	Crankshaft	85 x 105 x 12 NBR
06 56289 0183	113665	514950	20016781	Crankshaft	90 x 110 x 13 FPM
06 56289 0186	70576	255637	12011349	Rear Axle	140 x 160 x 13 NBR
06 56289 0187	114847		01017575	Crankshaft	170 x 190 x 15/14 NBR
06 56289 0191	47315	042420		Crankshaft	80 x 100 x 12 FPM
06 56289 0207	50801			Wheel Hub	100 x 120 x 13/10 NBR
06 56289 0215	81441				95 x 115 x 13 NBR
06 56289 0221	48002			Front Axle	120 x 150 x 15/12 NBR
06 56289 0221	18904	042943		Front Axle	120 x 150 x 15 NBR
06 56289 0223	42932		12000556	Crankshaft	120 x 140 x 13 NBR
06 56289 0236	18871	105422	01003701	Wheel Hub	110 x 140 x 13 NBR
06 56289 0241	18871				110 x 140 x 13 NBR
06 56289 0244	19889		12011213	Crankshaft	130 x 160 x 15 NBR

Disclaimer: OEM numbers are for reference only and do not imply that they are originals parts.



www.eurogasket.com.tr

SEALS – To Fit MAN



OEM Part Number	DPH Part Number	Elring Part Number	Corteco Part Number	Application	Dimensions
06 56289 0248	96262			Wheel Hub	145 x 175 x 14/12 FPM
06 56289 0266	114404		01019881	Crankshaft	85 x 150/169 x 12/31,5 FPM
06 56289 0267	61447			Front-Rear Axle	100 x 130 x 13 NBR
06 56289 0268	114420	3571470	01019880	Crankshaft	135 x 175 x 15,5/20 NBR
06 56289 0273	51723		12011398	Rear Axle	95 x 120 x 13 NBR
06 56289 0293	114398	379300	01020677	Crankshaft	80 x 135/154 x 13,5/18 FPM
06 56829 0306	81341		01017013	Crankshaft	130 x 160 x 16 FPM
06 56829 0309	82321	826774	01016698	Rear Axle	145 x 175 x 16 FPM
06 56829 0315	18831	519243	01018440	Crankshaft	100 x 130 x 12 NBR
06 56829 0319	95864	447080	01017059	Differential	85 x 145 x 12/37 FPM
06 56289 0320	113663		01027678	Crankshaft	81 x 100 x 10 NBR
06 56829 0321	36835		01020678	Crankshaft	90 x 110 x 10 NBR
06 56829 0322	82966		01018219	Crankshaft	95 x 115 x 10/9,5 NBR
06 56829 0323	113670		01018243	Crankshaft	95 x 120 x 10 NBR
06 56829 0324	18831		01018440	Crankshaft	100 x 130 x 12 NBR
06 56829 0325	82966		01018219	Crankshaft	95 x 115 x 10/9,5 NBR
06 56829 0329	114400		01029919	Crankshaft	85 x 110 x 10/14FPM
06 56829 0330	59311			Rear Axle	145 x 175 x 13 FPM
06 56829 0332	81021	768065	12014740	Rear Axle	145 x 175 x 14 NBR
06 56829 0333	59311		12014739	Wheel Hub	145 x 175 x 13 FPM
06 56829 0334	82427	817023	12015499	Rear Axle	145 x 175 x 13 NBR
06 56829 0335	81021	768065	12014740	Rear Axle	145 x 175 x 14 NBR
06 56829 0344	51488			Rear Axle	112 x 132 x 7,50 FPM
06 56829 0349	47995	104290	01020467	Differential	80 x 100 x 10 FPM
06 56829 0353	42528	104330	01020468	Crankshaft	80 x 100 x 10 NBR
06 56829 0357	93554		01029594	Differential	85 x 105 x 9,5/13 FPM
06 56829 0361	93553		01029595	Differential	85 x 105 x 13/9,5 NBR
06 56829 0365	94702	104470	01019888	Front Axle	160 x 180 x 10 NBR
06 56829 0366	94701	104480	01019887	Front Axle	160 x 180 x 10 NBR
06 56829 0369	109686	374360	01020679	Wheel Hub	100 x 130 x 12 FPM
06 56829 0371	80460	147730	01027787	Rear Axle	145 x 175/205 x 9/14 NBR
06 56829 0385	81341	290180	01017013	Crankshaft	130 x 160 x 16 FPM
06 56829 0386	82321	826774	01016689	Rear Axle	145 x 175 x 16 FPM
06 56829 0387	111357	485890	12020156	Crankshaft	132 x 160 x 10 FPM
06 56289 0389	114413		01029917	Crankshaft	105 x 130 x 12/17 FPM
06 56829 0393	120126			Crankshaft	116 x 140 x 10 FPM
06 56829 0394	119376		01033971	Crankshaft	85 x 110 x 12/17 FPM

Disclaimer: OEM numbers are for reference only and do not imply that they are originals parts.



www.eurogasket.com.tr

SEALS – To Fit MAN



OEM Part Number	DPH Part Number	Elring Part Number	Corteco Part Number	Application	Dimensions
06 56292 0101	18992				200 x 230 x 15 NBR
51 01510 0072	15300				138 x 160 x 15 MVQ
51 01510 0077	15301				85 x 110 x 13/15 MVQ
51 01510 0133	37547			Crankshaft	120 x 140 x 13 MVQ
51 01510 0133	112531	090158	12014877	Crankshaft	120 x 140 x 13 FPM
51 01510 0138	112532	288039		Crankshaft	105 x 130 x 12 FPM
51 01510 0141	109246		01016688	Crankshaft	120 x 140 x 13 PTFE/ACM
51 01510 0150	112532			Crankshaft	105 x 130 x 12 FPM
51 01510 0151	109691	323772	12015384	Crankshaft	110 x 130 x 13 FPM/PTFE
51 01510 0152	109799	323780	12015383	Crankshaft	60,40 x 80 x 12 FPM
51 01510 0196	109246	766828	01016688	Crankshaft	120 x 140 x 13 PTFE/ACM
51 01510 0197	109245	766852	01017541	Crankshaft	105 x 130 x 12 PTFE
51 01510 0206	109246	766828	01016688	Crankshaft	120 x 140 x 13 PTFE/ACM
51 01510 0216	109246			Crankshaft	120 x 140 x 13 PTFE/ACM
51 01510 0218	109691	503208	20029606	Crankshaft	110 x 130 x 13 PTFE
51 01510 0219	114371	061680	15027677	Crankshaft	66 x 90 x 12 PTFE
51 01510 0226	109245	766852	01017541	Crankshaft	105 x 130 x 12 PTFE
51 01510 0228	109690	749983		Crankshaft	66 x 90 x 12 FPM
51 01510 0236	114411		20031177	Crankshaft	100 x 130 x 12 PTFE
51 01510 0273	114411	158510	20031177	Crankshaft	100 x 130 x 12 PTFE/ACM
51 01510 6004	109245	766852	01017541	Crankshaft	105 x 130 x 12 PTFE
51 96501 0535	114357		20031171	Crankshaft	55 x 70 x 8 PTFE/AEM
81 32050 0219	114348		12012592	Crankshaft	50,80 x 65 x 8 FPM
81 32050 0451	114390		12013860	Crankshaft	78 x 100 x 10 FPM
81 35710 6015	114870			Crankshaft	145 x 175 x 13/12 FPM
81 35295 0007	18333			Crankshaft	50 x 70 x 12 NBR
81 52403 6000	109812		01019466	ABS with pulse wheel	76 x 100/137 x 10/15,5 FPM
81 52403 6001	109813	265960	01026330	ABS with pulse wheel	81 x 100/137 x 10/15,5 FPM
81 52403 6005	113829	473310		Wheel Hub	95 x 116,50 x 11 FPM
81 52403 6006	113832			Wheel Hub	95 x 116,50 x 11 FPM
81 96501 0026	82396			Rear Axle	160 x 190 x 15 NBR
81 96501 0032	18223				45 x 62 x 10 NBR
81 96501 0136	48002			Front Axle	120 x 150 x 15/12 NBR
81 96501 0296	17670			Crankshaft	26 x 35 x 7 NBR
81 96501 0306	35205			Transmission	7 x 16 x 7 NBR
81 96501 0308	18162		01002684	Crankshaft	70 x 90 x 10 NBR
81 96501 0313	19033	037109			14 x 24 x 7 NBR

Disclaimer: OEM numbers are for reference only and do not imply that they are originals parts.



www.eurogasket.com.tr

SEALS – To Fit MAN



OEM Part Number	DPH Part Number	Eling Part Number	Corteco Part Number	Application	Dimensions
81 96501 0388	19269				22 x 30 x 7 NBR
81 96501 0410	113749		12013365	Gear Box	60 x 74 x 10/8 FPM
81 96501 0445	18431	446602		Transmission	55 x 80 x 10 NBR
81 96501 0446	50341	556807	12011340	Gear Box	85 x 105 x 10 NBR
81 96501 0448	18169	040339			42 x 60 x 10 NBR
81 96501 0477	19101			Injection Pump	11 x 17 x 4 NBR
81 96501 0485	20038				75 x 100 x 13 NBR
81 96501 0521	4378	038083	12014616	Gear Box	25 x 35 x 7 NBR
81 96501 0530	47303	008427			25 x 35 x 8 NBR
81 96501 0798	114350		01030105	Crankshaft	52 x 72 x 10 FPM
81 96501 0842	48010			Brake Camshaft	42 x 55 x 9 FPM
81 96501 0843	37347	010197		Rear Axle	42 x 58 x 7 NBR
81 96501 0859	94526	092614		Crankshaft	22 x 35 x 7 MVQ
81 96501 0860	97801	033146	12015499	Wheel Hub	145 x 175 x 13 FPM
81 96501 0861	81021		12014740	Rear Axle	145 x 175 x 14 NBR
81 96501 0862	82427			Rear Axle	145 x 175 x 13 NBR
81 96501 0864	4378			Gear Box	25 x 35 x 7 NBR
81 96501 0966	82528		12013757	Gear Box	85 x 105 x 10 FPM
81 96502 0117	48055	134600	01002919	Gear Box	25 x 32 x 5 NBR
81 96502 0200	35050		12013896	Gear Box	42 x 62 x 10 ACM
81 96502 0208	4047	033464	12013757	Gear Box	85 x 105 x 10 FPM
81 96502 0216	114351		01029920	Crankshaft	52 x 87 x 10/18 ACM
81 96502 0225	4545	033472	12011307	Gear Box	48 x 75 x 8 FPM
81 96502 0226	47988		12011306	Gear Box	48 x 69 x 10 FPM
81 96502 0247	50341	556807		Gear Box	85 x 105 x 10 NBR
81 96502 0248	81637	040991	12011331	Gear Box	48 x 65 x 10 NBR
81 96502 0251	47944		12014736	Gear Box	70 x 90 x 10 FPM
81 96502 0313	97662			Gear Box	125 x 150 x 10 FPM/ACM
81 96502 0326	17512	106208	12010825	Gear Box	20 x 35 x 7 NBR
81 96502 0349	97860	282200	12011062	Gear Box	105 x 130 x 12 NBR
81 96502 0350	48035	314994	01018282	Crankshaft	105 x 130 x 12 FPM
81 96502 0356	32164			Gear Box	26 x 37 x 7 NBR
81 96502 0403	96995	141960	01029746	Gear Box	52 x 68 x 8 FPM
81 96502 0451	96979		12012235	Crankshaft	95,3 x 114,29 x 11,88 FPM
81 96502 0676	114353		01020680		52 x 97 x 10/18 FPM
81 96502 0699	96082	762830			90 x 110 x 15 FPM
81 96502 0761	36792	284645	12011308	Gear Box	55 x 75 x 8 FPM

Disclaimer: OEM numbers are for reference only and do not imply that they are originals parts.



to fit- MERCEDES



www.eurogasket.com.tr

To fit MERCEDES BENZ

FULL SET GASKET

Engine Model / Description	Eurogasket Part Number	OEM Part Number	Product Picture
MERCEDES BENZ OM 314 Full Set Gasket Ø97 4 Cyl.	796 090 0620	314 010 0480 Elring No: 825 913	
MERCEDES BENZ OM 327 Full Set Gasket	783 090 6083	327 010 4027	
MERCEDES BENZ OM 346 Full Set Gasket	764 524 0810	346 586 0290 Elring No: 581 519	
MERCEDES BENZ OM 352 Full Set Gasket 6 Cyl.	758 524 9910	352 586 1190 Elring No: 826 871	
MERCEDES BENZ OM 355 Full Set Gasket 6 Cyl.	755 524 0710	355 586 0390 Elring No: 581 519	

Disclaimer: OEM numbers are for reference only and do not imply that they are originals parts.



www.eurogasket.com.tr

To fit **MERCEDES BENZ**

FULL SET GASKET

Engine Model / Description	Eurogasket Part Number	OEM Part Number	Product Picture
<p>MERCEDES BENZ OM 360 Full Set Gasket</p>	<p>740 090 6080</p>	<p>360 010 4020 Elring No: 337 731</p>	
<p>MERCEDES BENZ OM 364 Full Set Gasket 4 Cyl.</p>	<p>746 090 6080</p>	<p>364 010 4020 Elring No: 825 825</p>	
<p>MERCEDES BENZ OM 366 Full Set Gasket 6 Cyl.</p>	<p>744 090 4980</p>	<p>366 586 1290 Elring No: 826 750</p>	
<p>MERCEDES BENZ OM 401 Full Set Gasket Ø125 Rubber Metal Copper Metal</p>	<p>609 524 5010</p>	<p>401 586 5090 Elring No: 826 502</p>	
<p>MERCEDES BENZ OM 402 Full Set Gasket Ø125 Rubber Metal Copper Metal</p>	<p>608 524 5010</p>	<p>402 586 5090 Elring No: 826 561</p>	

Disclaimer: OEM numbers are for reference only and do not imply that they are originals parts.



www.eurogasket.com.tr

To fit **MERCEDES BENZ**

FULL SET GASKET

Engine Model / Description	Eurogasket Part Number	OEM Part Number	Product Picture
MERCEDES BENZ OM 402 A/LA Full Set Gasket	196 135	Elring No: 914 975	
MERCEDES BENZ OM 403 Full Set Gasket Ø125 Rubber Metal Copper Metal	607 524 5010	403 586 5090 Elring No: 826 626	
MERCEDES BENZ OM 404 Full Set Gasket Ø125 12 Cyl. Rubber Metal Copper Metal	606 524 5010	404 586 5090 Elring No: 826 634	
MERCEDES BENZ OM 407 Full Set Gasket	603 524 5010	407 586 5090 Elring No: 826 358	
MERCEDES BENZ OM 421 Full Set Gasket Ø128	689 524 5010	421 586 5090 Elring No: 826 391	

Disclaimer: OEM numbers are for reference only and do not imply that they are originals parts.



www.eurogasket.com.tr

To fit MERCEDES BENZ

FULL SET GASKET

Engine Model / Description	Eurogasket Part Number	OEM Part Number	Product Picture
<p>MERCEDES BENZ OM 422 Full Set Gasket Ø128</p> <p>Rubber Metal Copper Metal</p>	688 524 5010	<p>422 586 5090</p> <p>Elring No: 061 590</p>	
<p>MERCEDES BENZ OM 422 A/LA Full Set Gasket Ø128</p> <p>Rubber Metal Copper Metal</p>	688 524 5010	<p>422 586 5090</p> <p>Elring No: 826 642</p>	
<p>MERCEDES BENZ OM 423 Full Set Gasket Ø128</p>	687 524 5010	<p>423 586 5090</p> <p>Elring No: 826 669</p>	
<p>MERCEDES BENZ OM 427 Full Set Gasket Ø128</p>	683 524 5010	<p>427 586 5090</p> <p>Elring No: 829 366</p>	
<p>MERCEDES BENZ OM 441 Full Set Gasket Ø128</p> <p>Rubber Metal Copper Metal</p>	669 524 5010	<p>441 586 5090</p> <p>Elring No: 914 940</p>	





Disclaimer: OEM numbers are for reference only and do not imply that they are originals parts.

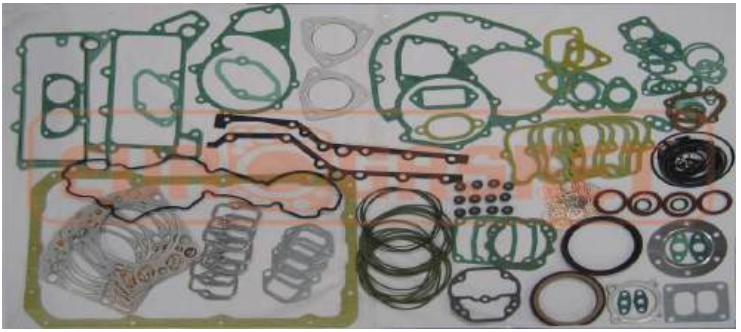

www.eurogasket.com.tr

To fit **MERCEDES BENZ**

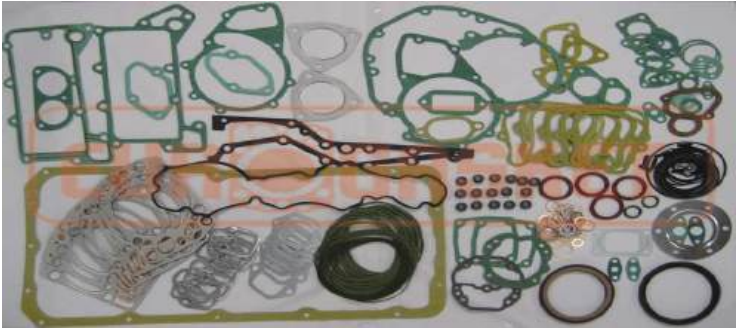
FULL SET GASKET

Engine Model / Description	Eurogasket Part Number	OEM Part Number	Product Picture
<p>MERCEDES BENZ OM 441 LA Full Set Gasket</p>	669 524 5010	<p>441 586 5090</p> <p>Elring No: 914 959</p>	
<p>MERCEDES BENZ OM 442 Full Set Gasket Ø128</p> <p>Rubber Metal Copper Metal</p>	668 524 5010	<p>442 586 5090</p> <p>Elring No: 914 967</p>	
<p>MERCEDES BENZ OM 442 LA Full Set Gasket Ø128</p> <p>Rubber Metal Copper Metal</p>	668 524 5010	<p>442 586 5090</p> <p>Elring No: 914 975</p>	
<p>MERCEDES BENZ OM 443 LA Full Set Gasket Ø128</p>	667 524 5010	443 586 5090	
<p>MERCEDES BENZ OM 444 LA Full Set Gasket Ø128</p>	666 524 5010	<p>444 586 5090</p> <p>Elring No: 826 677</p>	

Disclaimer: OEM numbers are for reference only and do not imply that they are originals parts.



www.eurogasket.com.tr

To fit MERCEDES BENZ

FULL SET GASKET

Engine Model / Description	Eurogasket Part Number	OEM Part Number	Product Picture
MERCEDES BENZ OM 447 Full Set Gasket Ø128	663 524 5010	447 586 5090 Elring No: 914 983	
MERCEDES BENZ OM 457 LA / HLA Full Set Gasket Ø128 6 Cyl.	653 090 0905	457 010 0105 Elring No: 136 290	
MERCEDES BENZ OM 501 LA – OM 541 Full Set Gasket Ø130 6 Cyl.	569 090 9705	541 010 0505 Elring No: 166 130	
MERCEDES BENZ OM 502 LA Full Set Gasket Ø130 8 Cyl.	568 090 0605	542 010 0405 Elring No: 166 350	
MERCEDES BENZ OM 904 LA Full Set Gasket 4 Cyl.	106 094 9080	904 016 1020 Elring No: 058 721	

Disclaimer: OEM numbers are for reference only and do not imply that they are originals parts.



www.eurogasket.com.tr

To fit **MERCEDES BENZ**

FULL SET GASKET

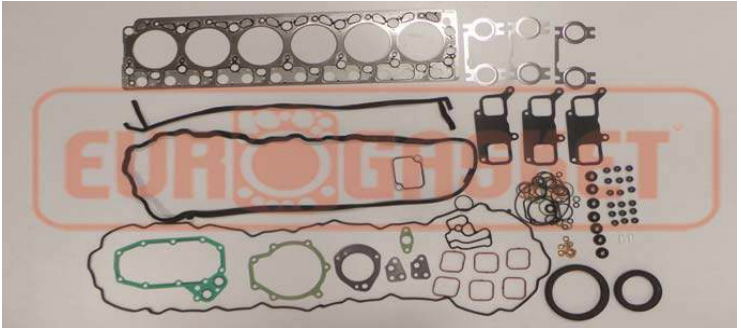
Engine Model / Description	Eurogasket Part Number	OEM Part Number	Product Picture
MERCEDES BENZ OM 906 LA Full Set Gasket 6 Cyl.	104 090 6505	906 010 4505 Etring No: 058 551	

Disclaimer: OEM numbers are for reference only and do not imply that they are originals parts.



www.eurogasket.com.tr

To fit MERCEDES BENZ

CONVERSION SET

Engine Model / Description	Eurogasket Part Number	OEM Part Number	Product Picture
MERCEDES BENZ OM 366 Gasket Set	744 090 6602	366 010 4408 Elring No: 817 481	
MERCEDES BENZ OM 401 – 421 - 441 Conversion Set	689 090 0602	421 010 0408 Elring No: 812 560	
MERCEDES BENZ OM 402 – 422 - 442 Conversion Set	687 090 0402	423 010 0608 Elring No: 812 587	
MERCEDES BENZ OM 457 Conversion Set	653 090 0905	457 010 0105 Elring No: 136 290	
MERCEDES BENZ OM 501 Conversion Set	569 090 0885	541 010 0225	

Disclaimer: OEM numbers are for reference only and do not imply that they are originals parts.



www.eurogasket.com.tr

To fit **MERCEDES BENZ**

CONVERSION SET

Engine Model / Description	Eurogasket Part Number	OEM Part Number	Product Picture
<p>MERCEDES BENZ OM 502 Conversion Set</p>	<p>568 090 0805</p>	<p>542 010 0205 Elring No: 166 350</p>	
<p>MERCEDES BENZ OM 904 Conversion Set</p>	<p>106 090 6505</p>	<p>904 010 4505 Elring No: 058 721</p>	
<p>MERCEDES BENZ OM 906 Conversion Set</p>	<p>104 090 6505</p>	<p>906 010 4505 Elring No: 058 551</p>	
<p>ADE 407 Bottom Set</p>	<p>304 608 27</p>	<p>706 402 83</p>	
<p>ADE 422 Bottom Set</p>	<p>304 608 30</p>	<p>706 402 70</p>	

Disclaimer: OEM numbers are for reference only and do not imply that they are originals parts.



www.eurogasket.com.tr

To fit MERCEDES BENZ

HEAD SET GASKET

Engine Model / Description	Eurogasket Part Number	OEM Part Number	Product Picture
MERCEDES BENZ OM 314 Head Set Gasket	796 090 4080	314 010 6020 Elring No: 817 465	
MERCEDES BENZ OM 352 Head Set Gasket	758 090 8489	352 010 2621 Elring No: 813 842	
MERCEDES BENZ OM 355 Head Set Gasket	755 090 9880	355 010 1220 Elring No: 820 637	
MERCEDES BENZ OM 360 Head Set Gasket	740 090 7780	360 010 3320 Elring No: 279 308	
MERCEDES BENZ OM 364 Head Set Gasket	746 090 6080	364 010 4020 Elring No: 813 869	





Disclaimer: OEM numbers are for reference only and do not imply that they are originals parts.

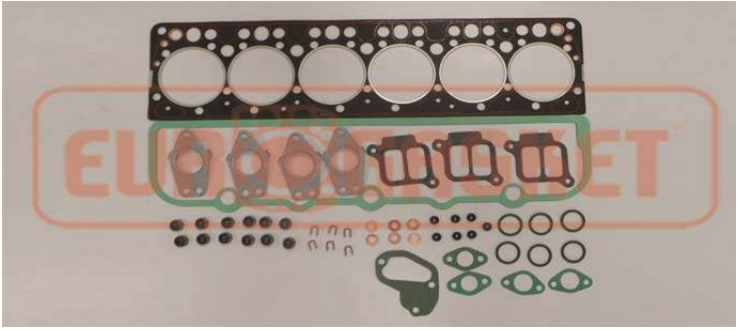

www.eurogasket.com.tr

To fit **MERCEDES BENZ**

HEAD SET GASKET

Engine Model / Description	Eurogasket Part Number	OEM Part Number	Product Picture
<p>MERCEDES BENZ OM 366 Head Set Gasket</p>	<p>744 090 4980</p>	<p>366 010 6120 Elring No: 813 877</p>	
<p>MERCEDES BENZ OM 401 / 402 / 403 / 404 / 407 / 421 / 422 / 423 / 441 / 442 Head Set Gasket Ø128 Rubber Metal</p>	<p>666 090 0980</p>	<p>444 010 0120 Elring No: 413 810</p>	
<p>MERCEDES BENZ OM 401 / 402 / 403 / 404 / 407 / 421 / 422 / 423 / 441 / 442 Head Set Gasket Ø125 - 128 Copper Metal</p>	<p>666 090 0980 663 090 0380</p>	<p>444 010 0120 447 010 0720 Elring No: 413 810</p>	
<p>MERCEDES BENZ OM 457 Head Set Gasket Ø128</p>	<p>653 090 3780</p>	<p>457 010 7320 Elring No: 264 715</p>	
<p>MERCEDES BENZ OM 501 - 502 Head Set Gasket Ø130</p>	<p>569 090 9980</p>	<p>541 010 1120 Elring No: 447 214</p>	

Disclaimer: OEM numbers are for reference only and do not imply that they are originals parts.



www.eurogasket.com.tr

To fit **MERCEDES BENZ**

CYLINDER HEAD GASKET

Engine Model / Description	Eurogasket Part Number	OEM Part Number	Product Picture
MERCEDES BENZ OM 314 Cylinder Head Gasket	746 094 0380	364 016 0720 Elring No: 089 176	
MERCEDES BENZ OM 327 Cylinder Head Gasket	783 094 0280	327 016 0820 Elring No: 183 441	
MERCEDES BENZ OM 346 Cylinder Head Gasket	764 094 0780	346 016 0320 Elring No: 173 968	
MERCEDES BENZ OM 352 Cylinder Head Gasket	744 094 0480	366 016 0620 Elring No: 760 677	
MERCEDES BENZ OM 355 Cylinder Head Gasket	755 094 0680	355 016 0420 Elring No: 749 541	

Disclaimer: OEM numbers are for reference only and do not imply that they are originals parts.



www.eurogasket.com.tr

To fit **MERCEDES BENZ**

CYLINDER HEAD GASKET

Engine Model / Description	Eurogasket Part Number	OEM Part Number	Product Picture
MERCEDES BENZ OM 360 Cylinder Head Gasket	740 094 0780	360 016 0320	
MERCEDES BENZ OM 364 Cylinder Head Gasket	746 094 0380	364 016 0720	
MERCEDES BENZ OM 366 Cylinder Head Gasket	744 090 0480	366 016 0620	
MERCEDES BENZ OM 401 / 402 / 403 / 407 Cylinder Head Gasket Ø125 – With Copper	688 094 0480	422 016 0620 Elring No: 748 080	
MERCEDES BENZ OM 401 / 402 Cylinder Head Gasket Ø125 – With Rubber	688 094 0780	422 016 0320 Elring No: 896 510	

Disclaimer: OEM numbers are for reference only and do not imply that they are originals parts.



www.eurogasket.com.tr

To fit **MERCEDES BENZ**

CYLINDER HEAD GASKET

Engine Model / Description	Eurogasket Part Number	OEM Part Number	Product Picture
MERCEDES BENZ OM 423 Cylinder Head Gasket Cyl. Ø125 – Ø128 Copper Metal	668 094 0680	442 016 0420 Elring No: 412 180	
MERCEDES BENZ OM 427 Cylinder Head Gasket Ø128	688 094 0680	422 016 0620 Elring No: 748 080	
MERCEDES BENZ OM 427 Cylinder Head Gasket Cyl. Ø125 – Ø128 Rubber Metal	668 094 0780	442 016 0320 Elring No: 896 510	
MERCEDES BENZ OM 421 / 422 / 441 / 442 / 444 / 447 Cylinder Head Gasket Ø125 - 128 Copper Metal	688 094 0480	422 016 0620 Elring No: 748 080	
MERCEDES BENZ OM 421 / 422 / 441 / 442 / 444 / 447 Cylinder Head Gasket Ø125 - 128 Rubber Metal	688 094 0780	422 016 0320 Elring No: 896 510	

Disclaimer: OEM numbers are for reference only and do not imply that they are originals parts.



www.eurogasket.com.tr

To fit **MERCEDES BENZ**

CYLINDER HEAD GASKET

Engine Model / Description	Eurogasket Part Number	OEM Part Number	Product Picture
MERCEDES BENZ OM 457 Cylinder Head Gasket Ø141,5	688 094 0480	457 016 1120 Elring No: 002 280	
MERCEDES BENZ OM 501 - 502 Cylinder Head Gasket Ø150	569 094 0180	541 016 0920 Elring No: 862 562	
MERCEDES BENZ OM 904 LA Cylinder Head Gasket	106 094 9780	904 016 1320 Elring No: 082 724	
MERCEDES BENZ OM 906 LA Cylinder Head Gasket	104 094 9680	906 016 1420 Elring No: 082 734	

Disclaimer: OEM numbers are for reference only and do not imply that they are originals parts.



www.eurogasket.com.tr

To fit MERCEDES BENZ

OIL PAN GASKET

Engine Model / Description	Eurogasket Part Number	OEM Part Number	Product Picture
MERCEDES BENZ OM 314 - 364 Oil Pan Gasket	796 090 0820 746 090 9920	314 010 0280 364 010 1180 Elring No: 088 863	
MERCEDES BENZ OM 314 - 364 Oil Pan Gasket	746 095 0920	364 015 0180 Elring No: 768 813	
MERCEDES BENZ OM 352 - 366 Oil Pan Gasket	758 090 0220	352 010 0880 Elring No: 284 734	
MERCEDES BENZ OM 355 Oil Pan Gasket	755 090 0083	355 010 0027 Elring No: 039 511	
MERCEDES BENZ OM 360 Oil Pan Gasket	740 096 0788	360 014 0322 Elring No: 819 612	

Disclaimer: OEM numbers are for reference only and do not imply that they are originals parts.



www.eurogasket.com.tr

To fit MERCEDES BENZ

OIL PAN GASKET

Engine Model / Description	Eurogasket Part Number	OEM Part Number	Product Picture
MERCEDES BENZ OM 366 Oil Pan Gasket	744 090 0420	366 010 0680 Elring No: 284 734	
MERCEDES BENZ OM 401 – 421 – 441 Oil Pan Gasket 6 Cyl.	669 096 0088	441 014 0022 Elring No: 765 695	
MERCEDES BENZ OM 401 – 421 – 441 Oil Pan Gasket 6 Cyl. Siliconed	669 096 0088	441 014 0022 Elring No: 765 696	
MERCEDES BENZ OM 402 – 422 - 442 Oil Pan Gasket 8 Cyl. Siliconed	668 096 0888	442 014 0222	
MERCEDES BENZ OM 402 – 422 - 442 Oil Pan Gasket 8 Cyl.	668 096 0888	442 014 0222	

Disclaimer: OEM numbers are for reference only and do not imply that they are originals parts.



www.eurogasket.com.tr

To fit MERCEDES BENZ

OIL PAN GASKET

Engine Model / Description	Eurogasket Part Number	OEM Part Number	Product Picture
MERCEDES BENZ OM 402 – 422 - 442 Oil Pan Gasket 4 PCS	668 096 9988	442 014 1122	
MERCEDES BENZ OM 403 – 423 - 443 Oil Pan Gasket 10 Cyl. Siliconed	667 096 0088	443 014 0022	
MERCEDES BENZ OM 403 – 423 - 443 Oil Pan Gasket 10 Cyl.	667 096 0088	443 014 0022	
MERCEDES BENZ OM 404 – 424 - 444 Oil Pan Gasket 12 Cyl.	666 096 0088	444 014 0022 Elring No: 775 789	
MERCEDES BENZ OM 457 Oil Pan Gasket	663 096 0086	447 014 0024	

Disclaimer: OEM numbers are for reference only and do not imply that they are originals parts.



www.eurogasket.com.tr

To fit MERCEDES BENZ

OIL PAN GASKET

Engine Model / Description	Eurogasket Part Number	OEM Part Number	Product Picture
MERCEDES BENZ OM 501 Oil Pan Gasket	569 096 0788	541 014 0322 Elring No: 445 980	
MERCEDES BENZ OM 501 Oil Pan Gasket (Rubber)	569 096 0588	541 014 0522 Elring No: 470 182	
MERCEDES BENZ OM 502 Oil Pan Gasket	568 096 0788	542 014 0322 Elring No: 445 991	
MERCEDES BENZ OM 904 LA Oil Pan Gasket (Rubber)	106 094 0488	904 016 0622	
MERCEDES BENZ OM 904 LA Oil Pan Gasket	106 096 0488	904 014 0622 Elring No: 211 570	



Disclaimer: OEM numbers are for reference only and do not imply that they are originals parts.



www.eurogasket.com.tr

To fit **MERCEDES BENZ**

OIL PAN GASKET

Engine Model / Description	Eurogasket Part Number	OEM Part Number	Product Picture
MERCEDES BENZ OM 906 LA Oil Pan Gasket (Rubber)	104 096 0488	906 014 0622 Elring No: 104 440	
MERCEDES BENZ OM 906 LA Oil Pan Gasket	104 096 0188	906 014 0922 Elring No: 757 320	

Disclaimer: OEM numbers are for reference only and do not imply that they are originals parts.



www.eurogasket.com.tr

To fit **MERCEDES BENZ**

VALVE COVER GASKET

Product Details	Product Picture	Product Details	Product Picture
<p>MERCEDES BENZ OM 314 Valve Cover Gasket</p> <p>OEM No: 314 016 0321</p> <p>Eurogasket No: 796 094 0789</p> <p>Elring No: 778 079</p>		<p>MERCEDES BENZ OM 352 Valve Cover Gasket</p> <p>OEM No: 352 016 0921</p> <p>Eurogasket No: 758 094 0189</p> <p>Elring No: 777 773</p>	
<p>MERCEDES BENZ OM 355 Valve Cover Gasket</p> <p>OEM No: 355 016 0021</p> <p>Eurogasket No: 755 094 0089</p> <p>Elring No: 775 525</p>		<p>MERCEDES BENZ OM 360 Valve Cover Gasket</p> <p>OEM No: 360 016 0221</p> <p>Eurogasket No: 740 094 0889</p> <p>Elring No: 777 766</p>	
<p>MERCEDES BENZ OM 364 Valve Cover Gasket</p> <p>OEM No: 364 016 0121</p> <p>Eurogasket No: 746 094 0989</p> <p>Elring No: 768 839</p>		<p>MERCEDES BENZ OM 366 Valve Cover Gasket</p> <p>OEM No: 366 016 0321</p> <p>Eurogasket No: 744 094 0789</p> <p>Elring No: 768 820</p>	
<p>MERCEDES BENZ OM 403 Valve Cover Gasket</p> <p>OEM No: 403 016 0321</p> <p>Eurogasket No: 607 094 0789</p>		<p>MERCEDES BENZ OM 442 Valve Cover Gasket (Siliconed)</p> <p>OEM No: 442 016 0621</p> <p>Eurogasket No: 668 094 0489</p>	
<p>MERCEDES BENZ OM 442 Valve Cover Gasket (Metal)</p> <p>OEM No: 442 016 0621</p> <p>Eurogasket No: 668 094 0489</p> <p>Elring No: 977 438</p>		<p>MERCEDES BENZ OM 457 Valve Cover Gasket</p> <p>OEM No: 457 016 0021</p> <p>Eurogasket No: 653 094 0089</p>	

Disclaimer: OEM numbers are for reference only and do not imply that they are originals parts.



www.eurogasket.com.tr

To fit **MERCEDES BENZ**

VALVE COVER GASKET

Product Details	Product Picture	Product Details	Product Picture
<p>MERCEDES BENZ OM 457 Valve Cover Gasket (Rubber)</p> <p>OEM No: 457 016 0121</p> <p>Eurogasket No: 653 094 0989</p>		<p>MERCEDES BENZ OM 501 -502 Valve Cover Gasket (Rubber)</p> <p>OEM No: 541 016 0321</p> <p>Eurogasket No: 569 094 0789</p> <p>Elring No: 060 560</p>	
<p>MERCEDES BENZ OM 904 LA Valve Cover Gasket (Rubber)</p> <p>OEM No: 904 016 0621</p> <p>Eurogasket No: 106 094 0489</p>		<p>MERCEDES BENZ OM 906 LA Valve Cover Gasket (Rubber)</p> <p>OEM No: 906 016 0621</p> <p>Eurogasket No: 104 094 0489</p>	
<p>MERCEDES BENZ OM 906 LA Valve Cover Gasket</p> <p>OEM No: 906 016 0721</p> <p>Eurogasket No: 104 094 0389</p>			

Disclaimer: OEM numbers are for reference only and do not imply that they are originals parts.



www.eurogasket.com.tr

To fit **MERCEDES BENZ**

INTAKE MANIFOLD GASKET

Product Details	Product Picture	Product Details	Product Picture
<p>MERCEDES BENZ OM 346 - 355 Intake Manifold Gasket</p> <p>OEM No: 355 141 0280</p> <p>Eurogasket No: 755 969 0820</p> <p>Elring No: 213 240</p>		<p>MERCEDES BENZ OM 360 Intake Manifold Gasket</p> <p>OEM No: 360 141 0180</p> <p>Eurogasket No: 740 969 0920</p> <p>Elring No: 775 517</p>	
<p>MERCEDES BENZ OM 364 / 366 Intake Manifold Gasket</p> <p>OEM No: 366 141 0780</p> <p>Eurogasket No: 744 969 0320</p> <p>Elring No: 768 929</p>		<p>MERCEDES BENZ OM 401 – 402 – 403 – 421 – 422 – 441 - 447 Intake Manifold Gasket</p> <p>OEM No: 442 141 1780</p> <p>Eurogasket No: 668 969 9320</p> <p>Elring No: 896 365</p>	
<p>MERCEDES BENZ OM 457 Intake Manifold Gasket</p> <p>OEM No: 457 141 0080</p> <p>Eurogasket No: 653 969 0020</p> <p>Elring No: 401 410</p>		<p>MERCEDES BENZ OM 501 - 502 Intake Manifold Gasket</p> <p>OEM No: 541 098 0480</p> <p>Eurogasket No: 569 012 0620</p> <p>Elring No: 470 290</p>	

Disclaimer: OEM numbers are for reference only and do not imply that they are originals parts.



www.eurogasket.com.tr

To fit **MERCEDES BENZ**

EXHAUST MANIFOLD GASKET

Product Details	Product Picture	Product Details	Product Picture
<p>MERCEDES BENZ OM 314 Exhaust Manifold Gasket</p> <p>OEM No: 314 142 0380</p> <p>Eurogasket No: 796 968 0720</p> <p>Elring No: 108 367</p>		<p>MERCEDES BENZ OM 352 Exhaust Manifold Gasket</p> <p>OEM No: 352 142 0480</p> <p>Eurogasket No: 758 968 0620</p> <p>Elring No: 522 929</p>	
<p>MERCEDES BENZ OM 346 - 355 Exhaust Manifold Gasket</p> <p>OEM No: 345 142 0080</p> <p>Eurogasket No: 765 968 0020</p> <p>Elring No: 558 192</p>		<p>MERCEDES BENZ OM 360 Exhaust Manifold Gasket</p> <p>OEM No: 360 142 0380</p> <p>Eurogasket No: 740 968 0720</p> <p>Elring No: 309 052</p>	
<p>MERCEDES BENZ OM 364 / 366 Exhaust Manifold Gasket</p> <p>OEM No: 366 142 0880</p> <p>Eurogasket No: 744 968 0220</p> <p>Elring No: 137 410</p>		<p>MERCEDES BENZ OM 401 – 402 – 403 – 421 – 422 – 441 - 447 Exhaust Manifold Gasket</p> <p>OEM No: 403 142 0380</p> <p>Eurogasket No: 607 968 0720</p> <p>Elring No: 225 126</p>	
<p>MERCEDES BENZ OM 457 – 501 - 502 Exhaust Manifold Gasket</p> <p>OEM No: 541 142 0280</p> <p>Eurogasket No: 569 968 0820</p> <p>Elring No: 432 040</p>			

Disclaimer: OEM numbers are for reference only and do not imply that they are originals parts.



www.eurogasket.com.tr

To fit **MERCEDES BENZ**

GASKET

Product Details	Product Picture	Product Details	Product Picture
<p>MERCEDES BENZ UNIMOG – O303 Glandular Gasket</p> <p>OEM No: 442 492 0080</p> <p>Eurogasket No: 668 618 0020</p> <p>Elring No: 778 060</p>		<p>MERCEDES BENZ OM 442 Gasket</p> <p>OEM No: 442 018 0080</p> <p>Eurogasket No: 668 092 0020</p> <p>Elring No: 756 785</p>	
<p>MERCEDES BENZ OM 314-352 Glandular Gasket</p> <p>OEM No: 312 492 1080</p> <p>Eurogasket No: 798 618 9020</p>			

Disclaimer: OEM numbers are for reference only and do not imply that they are originals parts.



www.eurogasket.com.tr

To fit **MERCEDES BENZ**

TURBO GASKET

Product Details	Product Picture	Product Details	Product Picture
<p>MERCEDES BENZ OM 366-401-402-422-441-442 Turbo Gasket</p> <p>OEM No: 442 187 0080</p> <p>Eurogasket No: 668 923 0020</p> <p>Elring No: 756 866</p>		<p>MERCEDES BENZ OM 366-401-402-422-441-442 Turbo Gasket</p> <p>OEM No: 442 187 0180</p> <p>Eurogasket No: 668 923 0920</p> <p>Elring No: 756 874</p>	
<p>MERCEDES BENZ OM 366-401-402-422-441-442 Turbo Gasket</p> <p>OEM No: 422 142 0080</p> <p>Eurogasket No: 688 968 0020</p> <p>Elring No: 279 455</p>		<p>MERCEDES BENZ OM 421-441-442 Turbo Gasket Set</p> <p>OEM No: 421 142 0180</p> <p>Eurogasket No: 689 968 0920</p> <p>Elring No: 279 447</p>	
<p>MERCEDES BENZ OM 422-442 Turbo Gasket Set</p> <p>OEM No: 422 144 0280</p> <p>Eurogasket No: 688 966 0820</p> <p>Elring No: 285 226</p>		<p>MERCEDES BENZ OM 421-441-442 Turbo Gasket Set</p> <p>OEM No: 421 142 0180</p> <p>Eurogasket No: 689 968 0920</p>	
<p>MERCEDES BENZ OM 422-442 Turbo Gasket Set</p> <p>OEM No: 422 142 0080</p> <p>Eurogasket No: 688 968 0020</p>		<p>MERCEDES BENZ Turbo Gasket Set</p> <p>OEM No: 423 042 0080</p> <p>Eurogasket No: 687 068 0020</p>	
<p>MERCEDES BENZ OM 442 Turbo Gasket</p> <p>OEM No: 442 184 0480</p> <p>Eurogasket No: 668 926 0620</p>			

Disclaimer: OEM numbers are for reference only and do not imply that they are originals parts.



www.eurogasket.com.tr

To fit MERCEDES BENZ

GASKET

Engine Model / Description	Eurogasket Part Number	OEM Part Number	Product Picture
MERCEDES BENZ OM 442 Suction Gasket	668 969 0320	442 141 0780 Elring No: 756 830	
MERCEDES BENZ OM 442 Camshaft Cover Gasket	668 099 0020	442 011 0080 Elring No: 756 769	
MERCEDES BENZ OM 442 Swallow Rubber	668 095 0040	442 015 0060 Elring No: 759 139	
MERCEDES BENZ Flywheel Housing Set	687 090 6227	423 010 4883	
MERCEDES BENZ OM 352 Timing Case Gasket	758 095 0780	352 015 0320 Elring No: 184 268	



Disclaimer: OEM numbers are for reference only and do not imply that they are originals parts.



www.eurogasket.com.tr

To fit MERCEDES BENZ

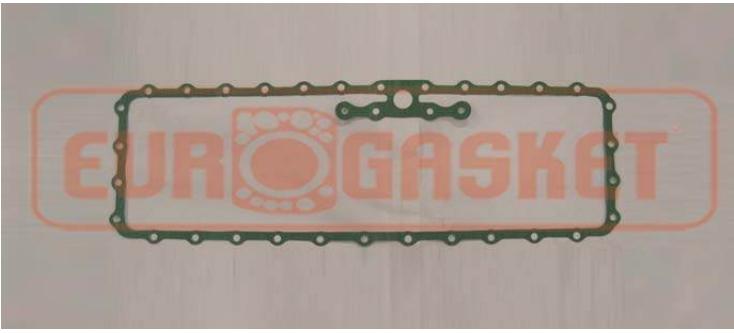
GASKET

Engine Model / Description	Eurogasket Part Number	OEM Part Number	Product Picture
MERCEDES BENZ OM 352 Side Cover Gasket	758 095 0588	352 015 0522 Elring No: 748 498	
MERCEDES BENZ OM 352 Oil Cooler Gasket	744 922 0820	366 188 0280 Elring No: 775 657	
MERCEDES BENZ OM 352 Oil Cooler Gasket	758 922 0220	352 188 0880	
MERCEDES BENZ OM 501-502 Flywheel Housing Set	569 090 0177	541 010 0933 Elring No: 633 360	
MERCEDES BENZ OM 501-502 Oil Cooler Gasket	569 926 0320	541 184 0780 Elring No: 052 351	

Disclaimer: OEM numbers are for reference only and do not imply that they are originals parts.



www.eurogasket.com.tr

To fit **MERCEDES BENZ**

GASKET

Engine Model / Description	Eurogasket Part Number	OEM Part Number	Product Picture
MERCEDES BENZ OM 501-502 Camshaft Cover Gasket	569 099 0920	541 011 0180 Elring No: 075 912	
MERCEDES BENZ OM 501-502 Timing Case Gasket	569 095 0940	541 015 0160 Elring No: 470 300	
MERCEDES BENZ OM 355 Oil Cooler Gasket	755 095 0089	355 015 0021 Elring No: 895 556	
MERCEDES BENZ OM 355 Timing Case Gasket	764 095 0980	346 015 0120 Elring No: 183 555	
MERCEDES BENZ OM 366 Block Cover Gasket	744 095 0040	366 015 0060 Elring No: 351 939	

Disclaimer: OEM numbers are for reference only and do not imply that they are originals parts.



www.eurogasket.com.tr

To fit MERCEDES BENZ

GASKET

Engine Model / Description	Eurogasket Part Number	OEM Part Number	Product Picture
MERCEDES BENZ OM 400 Gasket	400 754 0037		
MERCEDES BENZ OM 346 Gasket	764 754 0037	346 356 0073	
MERCEDES BENZ OM 364 Gasket (Rubber)	746 095 0740	364 015 0360 Elring No: 519 228	
MERCEDES BENZ OM 904 LA Gasket	106 926 0820	904 184 0280	
MERCEDES BENZ OM 906 LA Oil Cooler Gasket	104 922 0820	906 188 0280 Elring No: 215 070	

Disclaimer: OEM numbers are for reference only and do not imply that they are originals parts.



www.eurogasket.com.tr

To fit **MERCEDES BENZ**

GASKET

Engine Model / Description	Eurogasket Part Number	OEM Part Number	Product Picture
MERCEDES BENZ OM 366 Oil Filter Gasket	744 926 0020	366 184 0080	
MERCEDES BENZ OM 407-447 Timing Case Gasket	663 095 0020	447 015 0080 Elring No: 819 183	
MERCEDES BENZ Shim 0,15mm	668 099 051	442 011 0059 Elring No: 703214	
MERCEDES BENZ Shim 0,25mm	247080	Elring No: 863020	
MERCEDES BENZ Shim 0,50mm	668 099 0851	442 011 0259 Elring No: 896455	

Disclaimer: OEM numbers are for reference only and do not imply that they are originals parts.



www.eurogasket.com.tr

To fit **MERCEDES BENZ**

GEAR BOX GASKET

Engine Model / Description	Eurogasket Part Number	OEM Part Number	Product Picture
MERCEDES BENZ OM 355 Gear Box Gasket	000 524 0684	000 586 0426	
MERCEDES BENZ Gear Box Gasket	9841 812 177	1269 298 933	
MERCEDES BENZ 16 S Gear Box Gasket	9815 812 195	1295 298 915	
MERCEDES BENZ ACTROS-ATEGO Gearbox Gasket	450 754 0920	650 356 0180 Elring No: 570 569	
MERCEDES BENZ ACTROS Gearbox Gasket	450 754 0020	650 356 0080 Elring No: 567 673	

Disclaimer: OEM numbers are for reference only and do not imply that they are originals parts.



www.eurogasket.com.tr

To fit **MERCEDES BENZ**

OIL COOLER GASKET

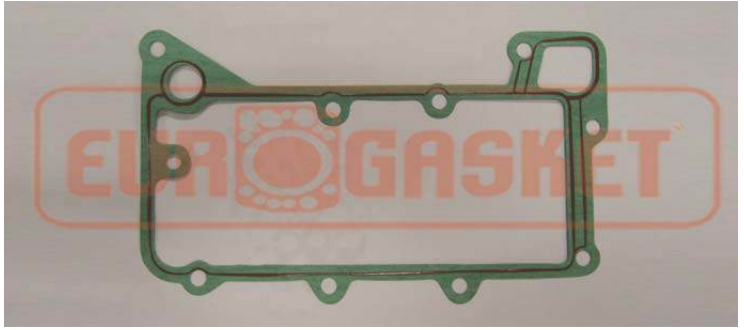
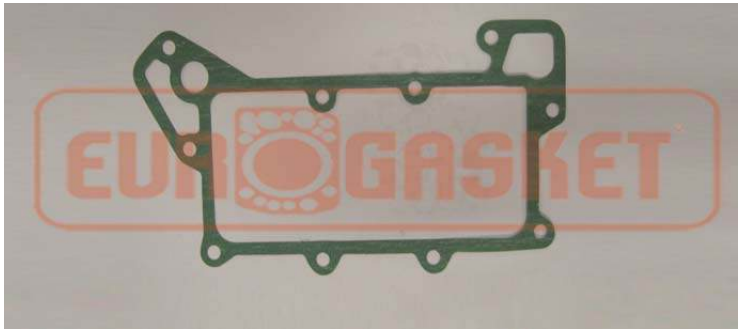
Engine Model / Description	Eurogasket Part Number	OEM Part Number	Product Picture
MERCEDES BENZ OM 422 Oil Cooler Gasket Siliconed	668 922 0520	442 188 0580 Elring No: 765 734	
MERCEDES BENZ OM 442 Oil Cooler Gasket	668 926 0520	442 184 0580 Elring No: 776 000	

Disclaimer: OEM numbers are for reference only and do not imply that they are originals parts.



www.eurogasket.com.tr

To fit **MERCEDES BENZ**

WATER PUMP GASKET

Engine Model / Description	Eurogasket Part Number	OEM Part Number	Product Picture
MERCEDES BENZ OM 366 Water Pump Gasket (Metal)	744 809 0620	366 201 0480 Elring No: 768 033	
MERCEDES BENZ OM 401/402/403/404 Water Pump Gasket	668 809 0020	442 201 0080 Elring No: 756 882	
MERCEDES BENZ OM 442 Water Pump Gasket	809 9020	201 1080	
MERCEDES BENZ OM 501-502 Water Pump Gasket	568 809 0920	542 201 0180 Elring No: 804 260	
MERCEDES BENZ OM 904-906 LA Water Pump Gasket	104 809 0020	906 201 0080 Elring No: 201 090	

Disclaimer: OEM numbers are for reference only and do not imply that they are originals parts.



www.eurogasket.com.tr

To fit MERCEDES BENZ

WATER PUMP GASKET

Engine Model / Description	Eurogasket Part Number	OEM Part Number	Product Picture
MERCEDES BENZ OM 501-502 Water Pump Gasket (Metal)	568 809 0920	542 201 0180 Etring No: 804 260	
MERCEDES BENZ OM 501-502 Water Pump Gasket	168 509 0020	942 501 0080	
MERCEDES BENZ O 302 - UNIMOG Water Pump Gasket	758 809 8920	352 201 2180	

Disclaimer: OEM numbers are for reference only and do not imply that they are originals parts.



www.eurogasket.com.tr

To fit **MERCEDES BENZ**

RUBBER & SEAL

Product Details	Product Picture	Product Details	Product Picture
<p>MERCEDES BENZ OM 401-402-403-407-421- 422-423-427-441-442-447 Pushrod Seal</p> <p>OEM No: 403 053 0196</p> <p>Eurogasket No: 607 057 0914</p> <p>Elring No: 193 658</p>		<p>MERCEDES BENZ OM 401-402-403-407-421- 422-423-427-441-442-447 Injector Rubber</p> <p>OEM No: 403 016 0061</p> <p>Eurogasket No: 607 094 0049</p> <p>Elring No: 558 060</p>	
<p>MERCEDES BENZ OM 422 Liner Rubber Ø128 144 x 151,6 x 3,8</p> <p>OEM No: 025 997 8548</p> <p>Eurogasket No: 085 113 2562</p> <p>Elring No: 538 090</p>		<p>MERCEDES BENZ OM 422 Liner Rubber Ø128 140 x 143,8 x 1,9</p> <p>OEM No: 025 997 8448</p> <p>Eurogasket No: 085 113 2662</p> <p>Elring No: 538 120</p>	
<p>MERCEDES BENZ OM 423 Liner Rubber 144 x 3,8 FPM Black</p> <p>OEM No: 423 011 0259</p> <p>Eurogasket No: 687 099 0851</p>		<p>MERCEDES BENZ OM 502LA ACTROS Liner Rubber</p> <p>OEM No: 541 997 0945</p> <p>Eurogasket No: 569 113 0165</p> <p>Elring No: 641 140</p>	
<p>MERCEDES BENZ OM 401-402-403-404-407 Liner Rubber</p> <p>OEM No: 009 997 8848</p> <p>Eurogasket No: 001 113 2262</p> <p>Elring No: 825 786</p>		<p>MERCEDES BENZ OM 401-402-403-404-407 Liner Rubber</p> <p>OEM No: 012 997 7148</p> <p>Eurogasket No: 098 113 3962</p> <p>Elring No: 825 794</p>	
<p>MERCEDES BENZ OM 401-402-403-404-407 421A-422-423-424-427- 441-444-447 Liner Rubber</p> <p>OEM No: 015 997 9048 Eurogasket No: 095 113 1062</p> <p>Elring No: 825 123</p>		<p>MERCEDES BENZ OM 401-402-403-404-407 421A-422-423-424-427- 441-444-447 Liner Rubber</p> <p>OEM No: 015 997 9148 Eurogasket No: 095 113 1962</p> <p>Elring No: 825 131</p>	

Disclaimer: OEM numbers are for reference only and do not imply that they are originals parts.



www.eurogasket.com.tr

To fit **MERCEDES BENZ**

RUBBER & SEAL

Product Details	Product Picture	Product Details	Product Picture
<p>MERCEDES BENZ OM 401-402-403-407 Liner Rubber Kit</p> <p>2 Pcs-009 997 8848 144 x 3,8 Green</p> <p>2 Pcs-012 997 7148 140 x 1,9 Green</p>		<p>MERCEDES BENZ OM 401-402-403-407- 421A-422-423-424-427- 441-444-447 Liner Rubber Kit</p> <p>2 Pcs-015 997 9048 140 x 109 Green</p> <p>2 Pcs-015 997 9148 144 x 3,8 Green</p>	
<p>MERCEDES BENZ OM 401-402-403-404-407- 421A-422-423-424-427- 441-444-447 Liner Rubber Ring Kit</p> <p>1 Pcs-442 011 0059 2 Pcs-015 997 9048 140 x 1,8 Green</p> <p>2 Pcs-015 997 9148 144 x 3,8 Green</p>		<p>MERCEDES BENZ ACTROS 1 Cyl. Liner Rubber Ring Kit</p> <p>1 x 541 011 0059 2 x 541 997 0945</p>	
<p>MERCEDES BENZ OM 457 LA Liner Rubber Ring Kit</p> <p>OEM No: 457 997 0545 Eurogasket No: 653 113 0565</p> <p>1 x 457 011 0259 1 x Liner Ring 144x154x7 FPM</p>			

Disclaimer: OEM numbers are for reference only and do not imply that they are originals parts.



to fit- RENAULT RVI



www.eurogasket.com.tr

To fit RENAULT-RVI

CONVERSION SET

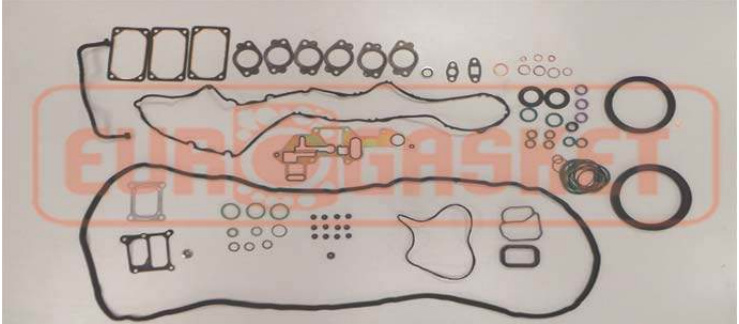
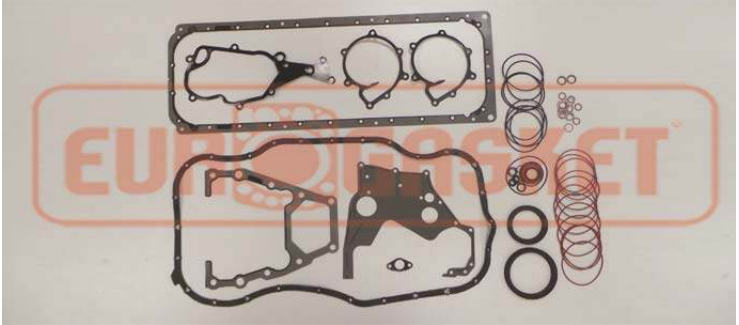
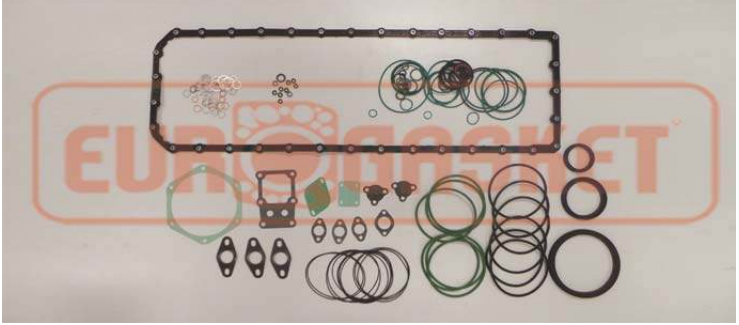
Engine Model / Description	Eurogasket Part Number	OEM Part Number	Product Picture
RENAULT RVI PREMIUM DXI KERAX DXI Conversion Set	5009 920 244 616	5001 180 866 494	
RENAULT RVI MIDLUM 220,170 PREMIUM 220,270 Conversion Set	5009 920 252 381	5001 180 858 729	
RENAULT RVI PREMIUM 385,400 KERAX Conversion Set	5009 920 276 531	5001 180 834 579	

Disclaimer: OEM numbers are for reference only and do not imply that they are originals parts.



www.eurogasket.com.tr

To fit RENAULT-RVI

HEAD SET GASKET

Engine Model / Description	Eurogasket Part Number	OEM Part Number	Product Picture
RENAULT RVI MDS 6BH12 Head Set Gasket 6 Cyl.	5000 317 376	5000 793 734 Elring No: 569 500	
RENAULT RVI MAGNUM Head Set Gasket	5009 270 208	5001 830 802 5001 014 263	
RENAULT RVI PREMIUM 370,420 KERAX Head Set Gasket	5009 935 253 678	5001 175 857 432	
RENAULT RVI PREMIUM 385,400 KERAX Head Set Gasket	5009 935 276 532	5001 175 834 578	
RENAULT RVI MIDR/S – MIPR/S 06.20.45 Head Set Gasket 1 Cyl.	5000 317 888	5000 793 222	

Disclaimer: OEM numbers are for reference only and do not imply that they are originals parts.



www.eurogasket.com.tr

To fit **RENAULT-RVI**

HEAD SET GASKET

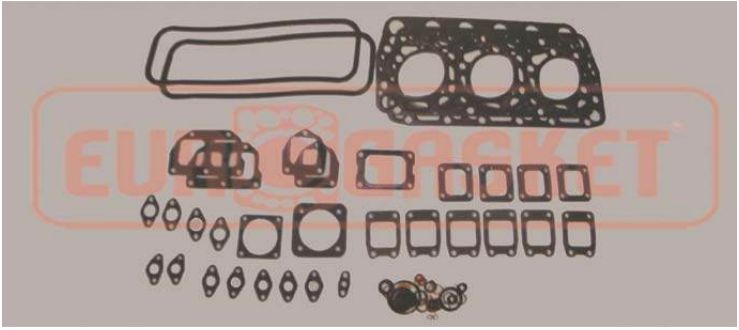
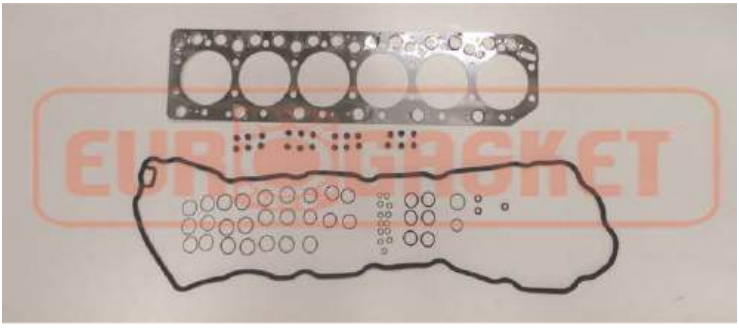
Engine Model / Description	Eurogasket Part Number	OEM Part Number	Product Picture
RENAULT RVI MIDR 06 35.40C R SERIES Head Set Gasket	5009 285 547	5001 825 563	
RENAULT Head Set Gasket	5009 244 617	5001 866 493	

Disclaimer: OEM numbers are for reference only and do not imply that they are originals parts.



www.eurogasket.com.tr

To fit RENAULT-RVI

CYLINDER HEAD GASKET

Engine Model / Description	Eurogasket Part Number	OEM Part Number	Product Picture
RENAULT-RVI BERLIT 06.35.40 G-H SERIES MAJOR Cylinder Head Gasket 6 Cyl. Ø135	5009 263 329	5001 847 781 Elring No: 572 360	
RENAULT-RVI BERLIT MAGNUM Cylinder Head Gasket 6 Cyl. Ø135	5000 432 471	5000 678 639 Elring No: 572 350	
RENAULT-RVI BERLIT KERAX - PREMIUM Cylinder Head Gasket	5000 430 808	5000 670 202	
RENAULT Cylinder Head Gasket	308 0615 175	702 0495 935	

Disclaimer: OEM numbers are for reference only and do not imply that they are originals parts.



www.eurogasket.com.tr

SEALS – To Fit RVI



OEM Part Number	DPH Part Number	Eling Part Number	Corteco Part Number	Application	Dimensions
0024 472 286	111803		07016683	Wheel Hub	100 x 120 x 12 NBR
0024 411 680	4546	251720	12011012	Crankshaft	68 x 90 x 10 NBR
0024 472 624	111756		01026300	Crankshaft	85 x 110 x 6 NBR
0024 472 709	84716		01016917	Crankshaft	120 x 150 x 15/12 NBR
50 0000 0813	50350		12011043	Crankshaft	90 x 110 x 112 NBR
5000 132 770	114432		12011015	Gear Box	70 x 90 x 12/8 NBR
5000 281 014	6729		12011407	Rear Axle	145 x 175 x 13 NBR
5000 288 417	114455				110 x 140 x 17 NBR
5000 294 202	17557		12010836	Crankshaft	22 x 35 x 7 NBR
5000 350 272	18390		12010980	Crankshaft	53 x 68 x 10 NBR
5000 387 566	113960		12017138	Rear Axle	69 x 80 x 4,2/8,5 NBR
5000 391 891	113962		07016685	Rear Axle	44 x 85 x 10 NBR
5000 392 404	113964		07016735	Wheel Hub	80 x 100 x 10 NBR
5000 515 606	113966		07016734	Wheel Hub	75 x 90 x 8 NBR
5000 545 227	113957		07013389	Wheel Hub	95 x 110 x 10 NBR
5000 546 916	113969		07016775	Wheel Hub	53 x 97 x 8 NBR
5000 654 396	113971		20016681	Wheel Hub	140 x 160 x 13 NBR
5000 671 980	110539		01016684	Wheel Hub	120 x 180 x 15 NBR
5000 675 159	18860		07016686	Wheel Hub	110 x 130 x 12 NBR
5000 675 975	113571		07016736	Crankshaft	85 x 130 x 17/26 FPM/ACM
5000 787 085	93224		07002931	Crankshaft	45 x 55 x 7 NBR
5000 788 400	18731	300896		Wheel Hub	85 x 110 x 13 NBR
5000 788 490	110539		01016684	Wheel Hub	120 x 160 x 15 NBR
5000 790 853	111753		07016381	Crankshaft	57 x 74 x 12,50 FPM
5000 804 940	114454			Crankshaft	98 x 115 x 6,5/13 NBR
5000 807 810	114437		01035692	Wheel Hub	100 x 120 x 10/9,5 FPM
5000 814 109	96979		12012235	Gear Box	95,3 x 114,29 x 11,88 FPM
5000 815 354	48055		01002919	Gear Box	25 x 32 x 5 NBR
5000 819 719	114341		20016209	Gear Box	48 x 65 x 10 AEM/PTFE
5000 819 970	114442			Gear Box	75 x 102 x 14 NBR
5000 823 891	114449		12016451	Wheel Hub	140 x 170 x 17 FPM
5000 823 986	84590			Injection Pump	25 x 35 x 7 NBR
5001 835 188	93393			Wheel Hub	117,48 x 152,4 x 25,4 NBR
5001 858 475	113971		20016681	Wheel Hub	140 x 160 x 13 NBR
5003 087 034	113975		20016794	Wheel Hub	120 x 140 x 13,5/15,5 FPM/ACM
5003 087 037	22997		01012190	Stub Axle	50 x 58 x 4 NBR
5010 067 534	111758		12014731	Crankshaft	100 x 125 x 13 NBR

Disclaimer: OEM numbers are for reference only and do not imply that they are originals parts.





to fit- SCANIA



www.eurogasket.com.tr

To fit **SCANIA**

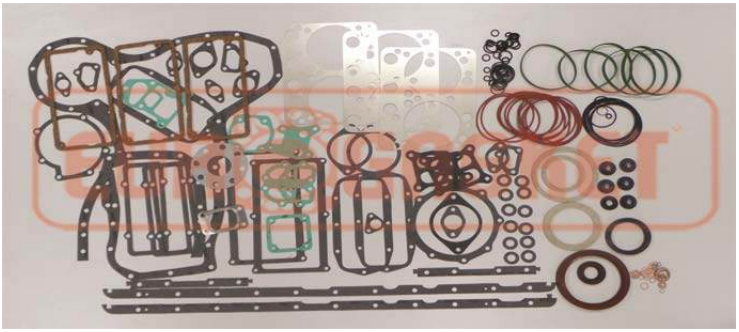
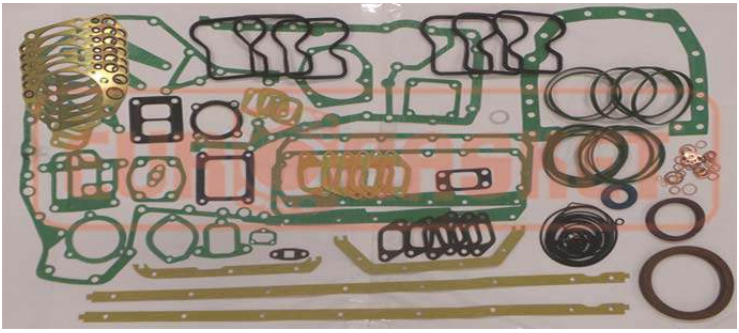
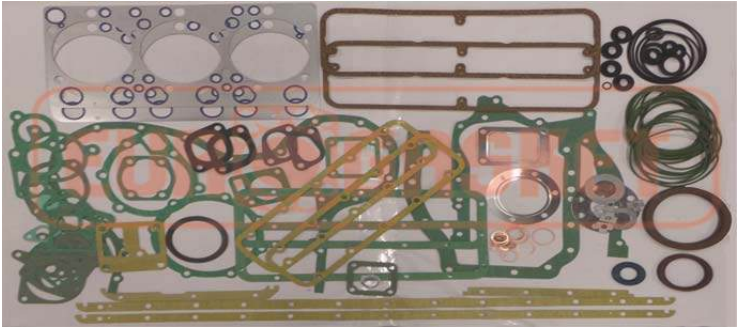
FULL SET GASKET

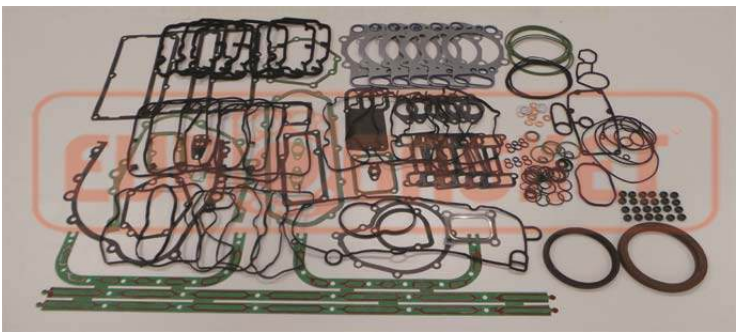
Engine Model / Description	Eurogasket Part Number	OEM Part Number	Product Picture
SCANIA DS 8 Full Set Gasket	559 694	551 416 Elring No: 283 801	
SCANIA DS 9 SCANIA DN9 R92-93 Full Set Gasket	559 661	551 449 Elring No: 922 323	
SCANIA DS 11 Full Set Gasket	559 594	551 516 Elring No: 347 516	
SCANIA DSC 11 Full Set Gasket	559 591	551 519 Elring No: 922 332	
SCANIA DSC 12 Full Set Gasket	559 754	551 356 Elring No: 159 690	

Disclaimer: OEM numbers are for reference only and do not imply that they are originals parts.



www.eurogasket.com.tr

To fit **SCANIA**

FULL SET GASKET

Engine Model / Description	Eurogasket Part Number	OEM Part Number	Product Picture
<p>SCANIA DSC 12 124-LGC Full Set Gasket</p>	<p>559 724</p>	<p>551 386 Elring No: 159 640</p>	
<p>SCANIA DS14 / DSC 14 Full Set Gasket R142 – R143</p>	<p>559 630</p>	<p>551 470 Elring No: 597 717</p>	
<p>SCANIA DC9- DSC9 Full Set Gasket</p>	<p>559 540</p>	<p>551 560 Elring No: 399 650</p>	
<p>SCANIA DC16 Full Set Gasket</p>	<p>559 723</p>	<p>551 387</p>	

Disclaimer: OEM numbers are for reference only and do not imply that they are originals parts.



www.eurogasket.com.tr

To fit **SCANIA**

HEAD SET GASKET

Engine Model / Description	Eurogasket Part Number	OEM Part Number	Product Picture
SCANIA DS 8 Head Set Gasket	559 695	551 415 Elring No: 284 158	
SCANIA DS 9 SCANIA DSC 9 Head Set Gasket	559 621 559 626	551 489 551 484 Elring No: 922 129	
SCANIA DS 11 Head Set Gasket	559 597	551 513 Elring No: 580 140	
SCANIA DSC 11 Head Set Gasket	559 598	551 512 Elring No: 921 807	
SCANIA DSC 12 Head Set Gasket	559 747	551 363 Elring No: 138 501	

Disclaimer: OEM numbers are for reference only and do not imply that they are originals parts.



www.eurogasket.com.tr

To fit **SCANIA**

HEAD SET GASKET

Engine Model / Description	Eurogasket Part Number	OEM Part Number	Product Picture
SCANIA DSC 12.01 - 02 Head Set Gasket	559 750	551 350 Elring No: 374 190	
SCANIA DS 14 Head Set Gasket	559 641	551 469 Elring No: 586 627	
SCANIA DC 16 Head Set Gasket	550 641	550 469 Elring No: 138 491	
SCANIA DC9 – DC16 Head Set Gasket	9 355 998	1 755 112	

Disclaimer: OEM numbers are for reference only and do not imply that they are originals parts.



www.eurogasket.com.tr

To fit **SCANIA**

CYLINDER HEAD GASKET

Engine Model / Description	Eurogasket Part Number	OEM Part Number	Product Picture
SCANIA DS 8 Cylinder Head Gasket	853 729	257 381 Elring No: 347 523	
SCANIA DS 9 Cylinder Head Gasket	9 607 852	1 403 258 Elring No: 893 463	
SCANIA DS 11 SCANIA DSC 11 Cylinder Head Gasket	737 638	373 472 Elring No: 331 092	
SCANIA DSC 12 Cylinder Head Gasket (Old Model)	9 607 840 9 666 169	1 403 260 1 444 941 Elring No: 125 780	
SCANIA DSC 12 Cylinder Head Gasket (New Model)	9 642 555	1 468 555	

Disclaimer: OEM numbers are for reference only and do not imply that they are originals parts.



www.eurogasket.com.tr

To fit **SCANIA**

CYLINDER HEAD GASKET

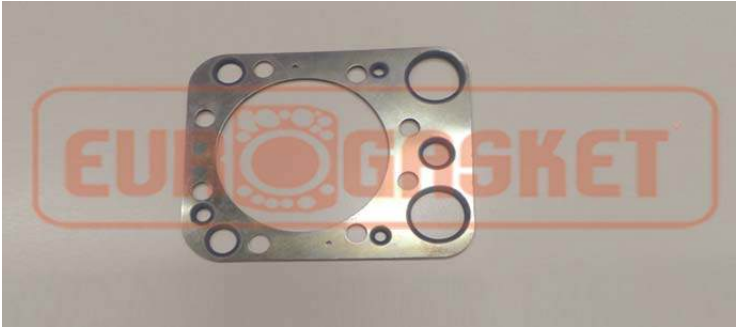
Engine Model / Description	Eurogasket Part Number	OEM Part Number	Product Picture
SCANIA DS 14 Cylinder Head Gasket	9 797 651	1 313 459 1 403 587 Etring No: 893 472	

Disclaimer: OEM numbers are for reference only and do not imply that they are originals parts.



www.eurogasket.com.tr

To fit **SCANIA**

OIL PAN GASKET

Engine Model / Description	Eurogasket Part Number	OEM Part Number	Product Picture
SCANIA DS 8 Oil Pan Gasket	559 664	551 446 Elring No: 749 533	
SCANIA DN9 SCANIA DS 9 SCANIA DSC 9 Oil Pan Gasket	744 571	366 539 Elring No: 767 549	
SCANIA DN11 SCANIA DS 11 SCANIA DSC 11 Oil Pan Gasket	739 507	371 503 Elring No: 767 174	
SCANIA DSC 12 Oil Pan Gasket	559 759	551 351 1 744 474 Elring No: 154 180	
SCANIA DS 14 / DSC 14 Oil Pan Gasket	739 505	371 505 Elring No: 001 652	

Disclaimer: OEM numbers are for reference only and do not imply that they are originals parts.



www.eurogasket.com.tr

To fit **SCANIA**

OIL PAN GASKET

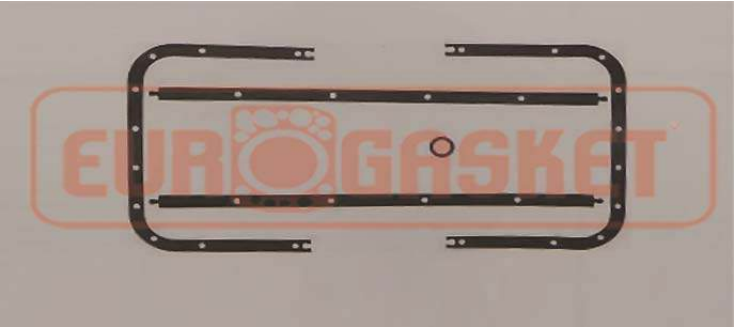
Engine Model / Description	Eurogasket Part Number	OEM Part Number	Product Picture
SCANIA 4 SERIES P/G/R/T SERIES Oil Pan Gasket	9 245 436	1 865 674 Elring No: 175 023	 A black metal oil pan gasket with a rectangular shape and rounded corners. It features several small holes along its perimeter and a central circular hole. The gasket is shown against a light gray background with a faint 'EUROGASKET' watermark.

Disclaimer: OEM numbers are for reference only and do not imply that they are originals parts.



www.eurogasket.com.tr

To fit **SCANIA**

VALVE COVER GASKET

Product Details	Product Picture	Product Details	Product Picture
<p>SCANIA DS 8 Valve Cover Gasket</p> <p>OEM No: 258 458</p> <p>Eurogasket No: 852 652</p> <p>Elring No: 280 615</p>		<p>SCANIA DS 9 Valve Cover Gasket</p> <p>OEM No: 378 299</p> <p>Eurogasket No: 732 811</p> <p>Elring No: 921 998</p>	
<p>SCANIA DS 11 Valve Cover Gasket</p> <p>OEM No: 258 459</p> <p>Eurogasket No: 852 651</p> <p>Elring No: 280 623</p>		<p>SCANIA DC 12 / DT 12 Valve Cover Gasket</p> <p>OEM No: 1 401 984</p> <p>Eurogasket No: 9 609 126</p> <p>Elring No: 125 840</p>	
<p>SCANIA DSC 12 SCANIA DC 11 / DC 12 SCANIA DT 12 Valve Cover Gasket</p> <p>OEM No: 1 411 851</p> <p>Eurogasket No: 9 699 259</p> <p>Elring No: 060 600</p>		<p>SCANIA DC 11-12 Valve Cover Gasket</p> <p>OEM No: 1 476 506 1 401 982</p> <p>Eurogasket No: 9 634 504</p> <p>Elring No: 060 620</p>	
<p>SCANIA DSC 12 Valve Cover Gasket</p> <p>OEM No: 1 414 422</p> <p>Eurogasket No: 9 696 688</p> <p>Elring No: 060 660</p>		<p>SCANIA DSC12 Valve Cover Gasket</p> <p>OEM No: 1 367 028</p> <p>Eurogasket No: 9 743 082</p> <p>Elring No: 125 870</p>	
<p>SCANIA DSC12 Valve Cover Gasket</p> <p>OEM No: 1 367 027</p> <p>Eurogasket No: 9 743 083</p> <p>Elring No: 060 710</p>		<p>SCANIA DS 14 / DSC 14 Valve Cover Gasket</p> <p>OEM No: 1 305 959</p> <p>Eurogasket No: 9 705 151</p> <p>Elring No: 001 393</p>	

Disclaimer: OEM numbers are for reference only and do not imply that they are originals parts.



www.eurogasket.com.tr

To fit **SCANIA**

VALVE COVER GASKET

Product Details		Product Picture	
SCANIA 4 SERIES P/G/R/T Valve Cover Gasket OEM No: 1 505 366 Eurogasket No: 9 505 744 Elring No: 374 420			

Disclaimer: OEM numbers are for reference only and do not imply that they are originals parts.



www.eurogasket.com.tr

To fit **SCANIA**

INTAKE MANIFOLD GASKET

Product Details	Product Picture	Product Details	Product Picture
<p>SCANIA DS 8 Intake Manifold Gasket</p> <p>OEM No: 277 662</p> <p>Eurogasket No: 833 448</p>		<p>SCANIA DS 9 – DSC 9 Intake Manifold Gasket</p> <p>OEM No: 329 498 / 366 547</p> <p>Eurogasket No: 781 612 / 744 563</p>	
<p>SCANIA DS 11 Intake Manifold Gasket</p> <p>OEM No: 277 632 / 393 820</p> <p>Eurogasket No: 833 478 / 717 280</p> <p>Elring No: 047 989</p>		<p>SCANIA DSC 11 Intake Manifold Gasket</p> <p>OEM No: 1 384 554 / 1 301 628</p> <p>Eurogasket No: 9 726 556 / 9 709 482</p> <p>Elring No: 893 330</p>	
<p>SCANIA DS 11 SCANIA DSC 11 Intake Manifold Gasket</p> <p>OEM No: 1 301 629</p> <p>Eurogasket No: 9 709 481</p> <p>Elring No: 893 350</p>		<p>SCANIA DSC 12 Intake Manifold Gasket</p> <p>OEM No: 1 516 474</p> <p>Eurogasket No: 9 594 636</p> <p>Elring No: 152 140</p>	
<p>SCANIA DSC 12 Intake Manifold Gasket</p> <p>OEM No: 1 516 474 1 374 388</p> <p>Eurogasket No: 9 594 636-1</p>		<p>SCANIA DS 14 Intake Manifold Gasket</p> <p>OEM No: 371 510 1 392 459</p> <p>Eurogasket No: 739 590</p> <p>Elring No: 832 350</p>	
<p>SCANIA 4 SERIES P/G/R/T SERIES Intake Manifold Gasket</p> <p>OEM No: 1 390 211</p> <p>Eurogasket No: 9 710 899</p> <p>Elring No: 138 280</p>			

Disclaimer: OEM numbers are for reference only and do not imply that they are originals parts.



www.eurogasket.com.tr

To fit **SCANIA**

EXHAUST MANIFOLD GASKET

Product Details	Product Picture	Product Details	Product Picture
<p>SCANIA DS 8 Exhaust Manifold Gasket</p> <p>OEM No: 275 209</p> <p>Eurogasket No: 835 801</p>		<p>SCANIA DS 9 Exhaust Manifold Gasket</p> <p>OEM No: 364 792</p> <p>Eurogasket No: 746 318</p> <p>Elring No: 594 431</p>	
<p>SCANIA DS 11 Exhaust Manifold Gasket</p> <p>OEM No: 277 272</p> <p>Eurogasket No: 833 838</p>		<p>SCANIA DS 11 Exhaust Manifold Gasket</p> <p>OEM No: 277 273</p> <p>Eurogasket No: 833 837</p>	
<p>SCANIA DS 11 SCANIA DSC 11 Exhaust Manifold Gasket</p> <p>OEM No: 378 264</p> <p>Eurogasket No: 732 846</p> <p>Elring No: 893 374</p>		<p>SCANIA DSC 11 Exhaust Manifold Gasket</p> <p>OEM No: 1 109 288</p> <p>Eurogasket No: 9 901 822</p> <p>Elring No: 893 366</p>	
<p>SCANIA DSC 12 Exhaust Manifold Gasket</p> <p>OEM No: 1 309 051</p> <p>Eurogasket No: 9 701 059</p> <p>Elring No: 135 020</p>		<p>SCANIA DS 14 Exhaust Manifold Gasket</p> <p>OEM No: 369 276</p> <p>Eurogasket No: 741 834</p> <p>Elring No: 001 172</p>	



Disclaimer: OEM numbers are for reference only and do not imply that they are originals parts.



www.eurogasket.com.tr

To fit **SCANIA**

TURBO GASKET

Product Details		Product Picture	
<p>SCANIA DS 11 Turbo Gasket</p> <p>OEM No: 1 302 930</p> <p>Eurogasket No: 9 708 170</p> <p>Elring No: 314 812</p>		<p>SCANIA DS 11 Turbo Gasket</p> <p>OEM No:</p> <p>Eurogasket No:</p>	
<p>SCANIA DSC 12 Turbo Gasket</p> <p>OEM No: 1 393 937</p> <p>Eurogasket No: 9 717 173</p> <p>Elring No: 359 321</p>			

Disclaimer: OEM numbers are for reference only and do not imply that they are originals parts.



www.eurogasket.com.tr

To fit **SCANIA**

GASKET

Engine Model / Description	Eurogasket Part Number	OEM Part Number	Product Picture
SCANIA DS 11 Gasket	9 909 834	1 101 276	
SCANIA DS 11 Gasket	739 624	371 486	
SCANIA DS 11 Water Pump Gasket	879 315	231 795	
SCANIA DS 11 SCANIA DSC 11 Gasket	739 503	371 507 Elring No: 049 336	
SCANIA DS 11 SCANIA DSC 11 Gasket	819 284	291 826 Elring No: 345 474	

Disclaimer: OEM numbers are for reference only and do not imply that they are originals parts.



www.eurogasket.com.tr

To fit **SCANIA**

GASKET

Engine Model / Description	Eurogasket Part Number	OEM Part Number	Product Picture
SCANIA DS 9 SCANIA DS 11 SCANIA DS 14 Gasket	9 718 914	1 392 196	
SCANIA DS 14 Oil Cooler Gasket	977 22 40	133 88 60	
SCANIA DS 14 Gasket	971 8176	139 2934	
SCANIA DS 14 Gasket	971 8175	139 2935	
SCANIA DS 14 Gasket	971 8178	139 2932	

Disclaimer: OEM numbers are for reference only and do not imply that they are originals parts.



www.eurogasket.com.tr

To fit **SCANIA**

GASKET

Engine Model / Description	Eurogasket Part Number	OEM Part Number	Product Picture
SCANIA DSC 12 Gasket	9 736 784	1 374 326 Elring No: 136 990	
SCANIA DSC 12 Gasket	9 735 727	1 375 383 Elring No: 137 010	
SCANIA DC11 SCANIA DC-DSC12 Oil Cooler Gasket	9 761 613	1 349 497 Elring No: 157 540	
SCANIA DC9-11 SCANIA DC-DSC12 Oil Cooler Gasket	9 508 312	1 502 798 Elring No: 570 300	

Disclaimer: OEM numbers are for reference only and do not imply that they are originals parts.



www.eurogasket.com.tr

To fit **SCANIA**

GASKET

Engine Model / Description	Eurogasket Part Number	OEM Part Number	Product Picture
SCANIA DC9-11 SCANIA DC-DSC12 DC 16 Oil Cooler Gasket	9 626 345	1 484 765 Elring No: 136 790	
SCANIA DC9-11 SCANIA DC-DSC12 DC 16 Oil Cooler Gasket	9 626 344	1 484 766 Elring No: 138 290	
SCANIA 4 SERIES Flywheel Housing Gasket	9 736 783	1 374 327 Elring No: 136 930	
SCANIA 4 SERIES SCANIA 2-3 SERIES Flywheel Housing Gasket	9 722 428	1 388 682	
SCANIA 4 SERIES SCANIA 2-3 SERIES Flywheel Housing Gasket	9 571 418	1 539 692	

Disclaimer: OEM numbers are for reference only and do not imply that they are originals parts.



www.eurogasket.com.tr

To fit **SCANIA**

GASKET

Engine Model / Description	Eurogasket Part Number	OEM Part Number	Product Picture
SCANIA Water Pump Gasket			
SCANIA DC9-DC11 DC-DSC12 Gasket Timing Case	9 607 981	1 403 129 Elring No: 138 580	
SCANIA 4 SERIES Oil Cooler Gasket	789 119	321 991	
SCANIA DS14 Gasket	9 718 177	1 392 933	
SCANIA DSC12 Water Pump Gasket	9 736 766	1 374 344 Elring No: 138 450	

Disclaimer: OEM numbers are for reference only and do not imply that they are originals parts.



www.eurogasket.com.tr

To fit **SCANIA**

GASKET

Engine Model / Description	Eurogasket Part Number	OEM Part Number	Product Picture
SCANIA DS11 Gasket	815 835	295 275	
SCANIA DS14 Gasket	9 722 425	1 388 685	
SCANIA Gasket	9 736 967	1 374 143	
SCANIA DS14 Gasket	9 718 183	1 392 927	
SCANIA DS14 Gasket	9 718 181	1 392 929	

Disclaimer: OEM numbers are for reference only and do not imply that they are originals parts.



www.eurogasket.com.tr

To fit **SCANIA**

GASKET

Engine Model / Description	Eurogasket Part Number	OEM Part Number	Product Picture
SCANIA DS14 Gasket	9 780 118	1 320 992	
SCANIA DS14 Gasket	723 335	387 775 Elring No: 345 521	
SCANIA DS11 Fuel Pump Gasket	739 624	371 486	
SCANIA DS11 Gasket	739 623	371 487	
SCANIA DS14 Gasket	9 718 170	1 392 930	

Disclaimer: OEM numbers are for reference only and do not imply that they are originals parts.



www.eurogasket.com.tr

To fit **SCANIA**

GASKET

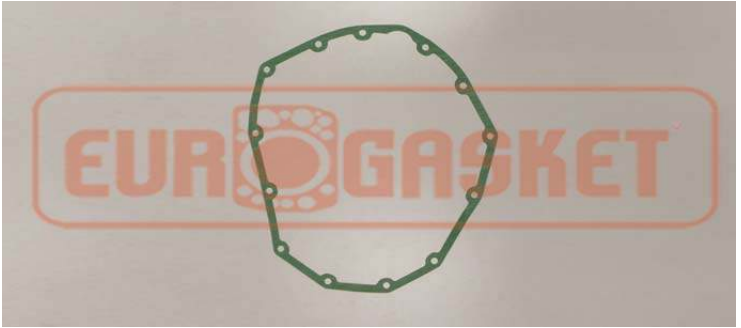
Engine Model / Description	Eurogasket Part Number	OEM Part Number	Product Picture
SCANIA Gear Box Gasket	9 705 971	1 305 139	

Disclaimer: OEM numbers are for reference only and do not imply that they are originals parts



www.eurogasket.com.tr

SEALS – To Fit SCANIA



OEM Part Number	DPH Part Number	Etring Part Number	Corteco Part Number	Application	Dimensions
1 100 645	111355		12013506	Crankshaft	54,1 x 70/74 x 7,5/11 NBR
1 104 500	112583		01019463	Crankshaft	50 x 70 x 9 FPM
1 109 869	82870		12014828	Crankshaft	30 x 47 x 10/7 ACM
1 109 870	84536	580202	12014830	Camshaft	35 x 62 x 7 ACM
1 109 871	112655		12014829	Crankshaft	42 x 72 x 8 ACM
1 120 864	112582		01033144	Crankshaft	40 x 60 x 9/8 FPM
1 122 619	112653		01026707	Crankshaft	35 x 52 x 10 ACM
1 122 620	112653		01026707	Crankshaft	35 x 52 x 10 ACM
1 303 673	96110			Wheel Hub	145 x 170 x 14,5/18 FPM
1 313 719	114389		12017173	Wheel Hub	75 x 100 x 10/13 NBR
1 318 388	96717		12015253	Gear Box	55 x 75 x 9 FPM
1 324 870	114344		01030356	Crankshaft	50 x 60 x 8 NBR
1 329 839	96427			Crankshaft	130 x 170 x 17 FPM
1 334 535	93429	457590	12016695	Crankshaft	125 x 150 x 14 NBR
1 335 243	112617		12015254	Crankshaft	80 x 100 x 10/8 ACM
1 336 001	118919			Crankshaft	140 x 165 x 15 NBR/MVQ
1 342 363	93428			With Polrad	
1 342 708	104925		19026423	Wheel Hub	149,9 x 176 x 16 NBR
1 343 372	112601		01026542	Steering	45 x 60 x 6,5/8 NBR
1 345 278	95642		01031705	Crankshaft	44,45 x 60 x 7 NBR
1 345 279	95643		01034657	Brake Camshaft	44,45 x 60 x 10/15 NBR
1 349 089	95644		01031712	Brake Camshaft	38,1 x 50 x 6,8
1 357 268	109213			Steering	56 x 72 x 7 NBR
1 363 673	96110			Wheel Hub	145 x 170 x 14,5/18 FPM
1 363 674	109377	919888	12017426	Crankshaft	158 x 188 x 14,5/18 FPM
1 375 002	111451	090510	15026917	Crankshaft	145 x 175 x 13 PTFE
1 379 477	109213			Crankshaft	56 x 72 x 7 NBR
1 383 129	112634		12018653	Crankshaft	84,93 x 104,77 x 18,26 FPM/ACM
1 386 594	112634	222630	12018653	Crankshaft	84,93 x 104,77 x 18,26 FPM/ACM
1 392 708	116003	152320		Crankshaft	120 x 140 x 12 PTFE/AEM
1 393 331	111372			Front Axle	85 x 105 x 18 SP LD
1 393 331	112636	222640	12018654	Front Axle	84,93 x 104,77 x 12/18,26 FPM/ACM
1 395 999	109213			Steering	56 x 72 x 7 NBR
1 409 889	112790	222620	12020496	Wheel Hub	142 x 170 x 15/16 NBR
1 409 890	114389	222610	12017173	Wheel Hub	75 x 100 x 10/13 NBR
1 415 136	114448		12019945	Crankshaft	130 x 170 x 18/20 FPM
1 426 876	96429		01016959	Crankshaft	72 x 90 x 12/9,5 NBR

Disclaimer: OEM numbers are for reference only and do not imply that they are originals parts.



www.eurogasket.com.tr

SEALS – To Fit SCANIA



OEM Part Number	DPH Part Number	Etring Part Number	Corteco Part Number	Application	Dimensions
1 433 183	111451	090510	15026917	Crankshaft	145 x 175 x 13 PTFE
1 433 186	82427			Rear Axle	145 x 175 x 13 NBR
1 502 384	112636	222640	12018654	Crankshaft	84,93 x 104,77 x 12/18,26 FPM/ACM
1 502 385	112634	222630	12018653	Crankshaft	84,93 x 104,77 x 18,26 FPM/ACM
1 528 043	114460			Wheel Hub	158 x 188 x 16 FPM
120 828	70213	040606	12010950	Crankshaft	45 x 60 x 7 NBR
120 979	4306	546038	12011026	Front-Rear Axle	80 x 100 x 10 NBR
121 257	24777		20016795	Rear Axle	136,52 x 161,92 x 12,7 NBR
123 102	70214		12010923	Crankshaft	38 x 50 x 7 NBR
124 268	94928	042463		Rear Axle	80 x 100 x 13 NBR
124 268	118176		12015254	Rear Axle	80 x 100 x 13/15 ACM
125 766	61487			Front-Rear Axle	70 x 90 x 10 NBR
130 934-2	109377			Crankshaft	158 x 188 x 14,5/18 FPM
132 672	17960		12010911	Crankshaft	35 x 58 x 10 NBR
136 106	17693		12000129	Steering	28 x 38 x 7 NBR
139 023	17741		12000480	Transfer Gearbox	30 x 47 x 7 NBR
139 038	17768		12010887	Wheel Hub	30 x 52 x 10 NBR
14 107	18328		12010969	Crankshaft	50 x 70 x 10 NBR
144 116	17780		12010889	Crankshaft	30 x 55 x 10 NBR
159 496	84589	325503	12011092	Wheel Hub	150,81 x 177,8 x 12,7 NBR
170 072	17745			Crankshaft	30 x 47 x 10 NBR
170 074	17766			Injection	30 x 52 x 8 NBR
170 075	84542			Injection Pump	30 x 42 x 6/6,8
170 226	112655		12014829	Crankshaft	42 x 72 x 8 ACM
170 761	68544	038326	12010858	Crankshaft	25 x 47 x 10 NBR
173 320	84532	325511	12011073	Crankshaft	117,47 x 142,87 x 12,7 NBR
178 866	45614	281972		Rear Axle	130 x 160 x 13 NBR
179 360	84589			Wheel Hub	150,81 x 117,8 x 12,7 NBR
192 600	84590	038075	12011122	Injection Pump	25 x 35 x 7 NBR
195 532	47945			Steering	26 x 37 x 7/8 NBR
202 288	81456			Rear Axle	42 x 62 x 6 NBR
210 648	17448		12011112	Differential	17 x 28 x 7 NBR
210 743	47959		12011118	Crankshaft	20 x 40 x 7/8 NBR
211 337	47303	008427		Steering	25 x 35 x 8 NBR
214 005	84538		12010967	Crankshaft	50 x 68 x 8 NBR
214 008	81437		12002888	Differential	90 x 110 x 14 NBR
216 608	18683	042390		Gear Box	80 x 100 x 10 NBR

Disclaimer: OEM numbers are for reference only and do not imply that they are originals parts.



www.eurogasket.com.tr

SEALS – To Fit SCANIA



OEM Part Number	DPH Part Number	Etring Part Number	Corteco Part Number	Application	Dimensions
227 138	4306			Front-Rear Axle	80 x 100 x 10 NBR
228 109	84536	269700		Injection	35 x 62 x 7 ACM
231 938	48518	587079	12013893	Crankshaft	130 x 160 x 15 MVQ
244 249	18232		12010955	Crankshaft	45 x 65 x 8 NBR
244 710	93690		01026396	Crankshaft	45 x 55 x 7 ACM
254 635	4378	038083	12014487	Gear Box	25 x 35 x 7 NBR
280 759	84542		11014231	Injeciton Pump	30 x 42 x 6/6,8 NBR
291 076	50174	586838	12011388	Rear Axle	145 x 170 x 15/20 NBR
291 463	50175	598925	12011917	Wheel Hub	155 x 180 x 24/29 FPM
294 275	84540		12001716	Crankshaft	75 x 90 x 10/11 NBR
297 991	61646	586803	12012241	Crankshaft	137 x 161,92 x 15/12 NBR
297 999	61642	586781	12014734	Rear Axle	113 x 136 x 10,9 NBR
300 278	82425		01002741	Front Wheel Hub	110 x 140 x 12/21 NBR
304 552	18694		12011029	Crankshaft	80 x 110 x 10 NBR
309 113	24964		12012234	Reductor Hub	161,92 x 187,32 x 12,7 NBR
310 951	84536		12014830	Injection Pump	35 x 62 x 7 ACM
310 953	112655		12014829	Crankshaft	42 x 72 x 8 ACM
314 063	81126	325562	12011970	Gear Box	45 x 65 x 9 ACM
318 996	47945	006408	12014826	Steering	26 x 37 x 7/8 NBR
32201	17934	258407	12010899	Gear Box	35 x 52 x 10 NBR
32 898	84534			Front Axle	120,65 x 146,05 x 12,7 NBR
329 638	4468		12014616	Trasfer Gearbox	25 x 35 x 7 NBR
33 326	84533	325473	12011017	Crankshaft	70 x 100 x 12 NBR
33 352	84535	530107	12011021	Gear Box	75 x 100 x 10 NBR
338 643	34420	527823	12011821	Crankshaft	80 x 100 x 12 FPM
347 468	109212				56 x 70 x 6 NBR
350 984	81798		01015140	Axle	125 x 160 x 17 FPM
366 303	93307	587070	12013893	Crankshaft	130 x 160 x 15 FPM
368 542	112591		01034659	Crankshaft	105 x 140 x 13/12 NBR
369 477	111403	382100	20017234	Crankshaft	80 x 100 x 13 PTFE
369 478	111404	354390	20017235	Crankshaft	130 x 160 x 13 PTFE
370 074	61646		12012241	Rear Axle	137 x 161,92 x 15/12 NBR
370 075	50175	598925	12011917	Wheel Hub	155 x 180 x 24/29 FPM
370 076	50174	586838	12011388	Crankshaft	145 x 170 x 15/20 NBR
370 076	111230			Crankshaft	145 x 170 x 15/12 FPM
375 086	61648		12014463	Crankshaft	125 x 160 x 15 NBR
375 087	61650		12014464	Front Axle	110 x 140 x 15 NBR

Disclaimer: OEM numbers are for reference only and do not imply that they are originals parts.



to fit- VOLVO



www.eurogasket.com.tr

To fit VOLVO

FULL SET GASKET

Engine Model / Description	Eurogasket Part Number	OEM Part Number	Product Picture
VOLVO TD 50 – 60 Full Set Gasket	830 331-8 F	270 779-2 F	
VOLVO TD 61 Full Set Gasket	834 289 F	276 821 F	
VOLVO TD 70 Full Set Gasket	830 349-0 F	270 761-0 F	
VOLVO TD 71 Full Set Gasket	834 294 F	276 816 F	
VOLVO TD 100 Full Set Gasket	835 559-0 F	275 551-0 F	



Disclaimer: OEM numbers are for reference only and do not imply that they are originals parts.



www.eurogasket.com.tr

To fit VOLVO

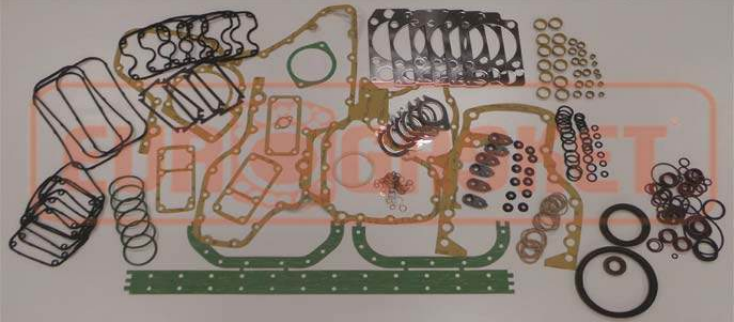
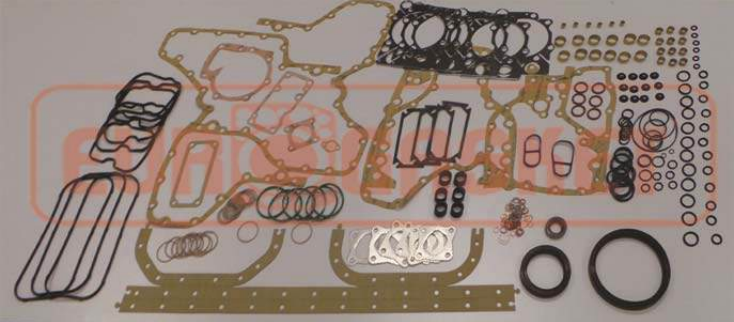
FULL SET GASKET

Engine Model / Description	Eurogasket Part Number	OEM Part Number	Product Picture
VOLVO TD 101 – 102 - 103 Full Set Gasket	830 321-9 F	270 789-1 F	
VOLVO TD 120 Full Set Gasket	835 562-4 F	275 548-6 F	
VOLVO TD 121- 122 - 123 Full Set Gasket	835 556-6 F	275 554-4 F	

Disclaimer: OEM numbers are for reference only and do not imply that they are originals parts.



www.eurogasket.com.tr

To fit VOLVO

CONVERSION SET

Engine Model / Description	Eurogasket Part Number	OEM Part Number	Product Picture
VOLVO TD 50 - 60 Conversion Set	830 331	270 779	
VOLVO TD 60 B-C Conversion Set	830 332	270 778	
VOLVO TD 61 F-FB Conversion Set	830 336	270 774	
VOLVO TD 70 A-B Conversion Set	830 153	270 957	
VOLVO TD 71 F-FA Conversion Set	830 335	270 775	

Disclaimer: OEM numbers are for reference only and do not imply that they are originals parts.



www.eurogasket.com.tr

To fit VOLVO

CONVERSION SET

Engine Model / Description	Eurogasket Part Number	OEM Part Number	Product Picture
VOLVO TD 100 A-B Conversion Set	834 988	276 122	
VOLVO TD 101 F-FA Conversion Set	834 987	276 123	
VOLVO THD 101 Conversion Set	835 325	275 785	
VOLVO TD 120 – 121 Conversion Set	834 986	276 124	
VOLVO TD 122 Conversion Set	834 985	276 125	

Disclaimer: OEM numbers are for reference only and do not imply that they are originals parts.



www.eurogasket.com.tr

To fit VOLVO

CONVERSION SET

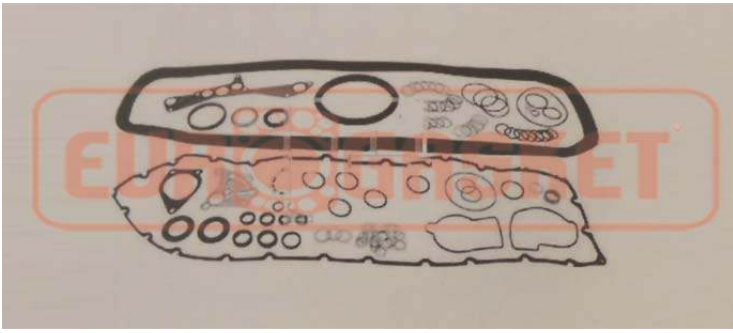
Engine Model / Description	Eurogasket Part Number	OEM Part Number	Product Picture
VOLVO TD 162F-FS Conversion Set	839 010 7 015 911	271 090 3 095 199	
VOLVO D12A/B Conversion Set	834 222	276 888	
VOLVO D12C Conversion Set	259 07477	851 03633	
VOLVO TD101-102 Gasket Set CS 201	26561		
VOLVO TD100 Gasket Set CS 200	29828		

Disclaimer: OEM numbers are for reference only and do not imply that they are originals parts.



www.eurogasket.com.tr

To fit VOLVO

CONVERSION SET

Engine Model / Description	Eurogasket Part Number	OEM Part Number	Product Picture
VOLVO TD120-121-122 Gasket Set CS 202	28851		

Disclaimer: OEM numbers are for reference only and do not imply that they are originals parts.



www.eurogasket.com.tr

To fit VOLVO

HEAD SET GASKET

Engine Model / Description	Eurogasket Part Number	OEM Part Number	Product Picture
VOLVO TD 50 - 60 Head Set Gasket	830 331-8 H	270 779-2 H Elring No: 109 763	
VOLVO TD 61 Head Set Gasket	835 336-2 H	275 774-8 H Elring No: 916 021	
VOLVO TD 70 Head Set Gasket	835 585-6 H	275 525-4 H Elring No: 109 704	
VOLVO TD 71 Head Set Gasket	835 331-3 H	275 779-7 H Elring No: 916 048	
VOLVO TD 100 Head Set Gasket	830 152-8 H	270 958-2 H Elring No: 087 301	

Disclaimer: OEM numbers are for reference only and do not imply that they are originals parts.



www.eurogasket.com.tr

To fit VOLVO

HEAD SET GASKET

Engine Model / Description	Eurogasket Part Number	OEM Part Number	Product Picture
VOLVO TD 101 – 102 - 103 Head Set Gasket	830 321-9 H	270 789-1 H Elring No: 917 087	
VOLVO TD 120 Head Set Gasket	835 562-4 H	275 548-6 H Elring No: 109 844	
VOLVO TD 122 - 123 Head Set Gasket	830 161-9 H	270 949-1 H Elring No: 917 109	
VOLVO FH 12 Head Set Gasket	834 235	276 875 Elring No: 390 100	
VOLVO TD162-163 Head Set Gasket	834 472	276 638	

Disclaimer: OEM numbers are for reference only and do not imply that they are originals parts.



www.eurogasket.com.tr

To fit VOLVO

HEAD SET GASKET

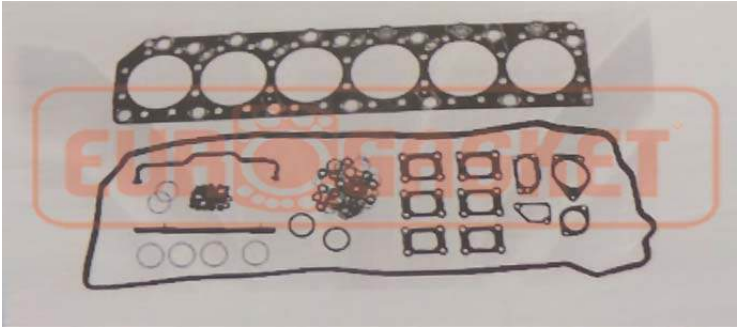
Engine Model / Description	Eurogasket Part Number	OEM Part Number	Product Picture
VOLVO D12C Head Set Gasket	803 90868 7 018 468	207 10242 3 092 642 Etring No: 390 210	

Disclaimer: OEM numbers are for reference only and do not imply that they are originals parts.



www.eurogasket.com.tr

To fit VOLVO

CYLINDER HEAD GASKET

Engine Model / Description	Eurogasket Part Number	OEM Part Number	Product Picture
VOLVO TD 50 - 60 Cylinder Head Gasket	835 360-1	275 740-9 Elring No: 518 301	
VOLVO TD 61 Cylinder Head Gasket	834 289-4	276 821-6 Elring No: 754 641	
VOLVO TD 70 Cylinder Head Gasket	835 585-6	275 525-4 Elring No: 108 197	
VOLVO TD 71 Cylinder Head Gasket	834 294-4	276 816-6 Elring No: 750 530	

Disclaimer: OEM numbers are for reference only and do not imply that they are originals parts.



www.eurogasket.com.tr

To fit VOLVO

CYLINDER HEAD GASKET

Engine Model / Description	Eurogasket Part Number	OEM Part Number	Product Picture
VOLVO TD 100 Cylinder Head Gasket	835 559-0	275 551-0 Elring No: 087 289	
VOLVO TD 101 – 102 - 103 Cylinder Head Gasket	830 321-9	270 789-1 Elring No: 755 206	
VOLVO TD 120 Cylinder Head Gasket	835 562-4	275 548-6 Elring No: 087 335	
VOLVO TD 121-122- 123 Cylinder Head Gasket	830 161-9	270 949-1 Elring No: 755 621	

Disclaimer: OEM numbers are for reference only and do not imply that they are originals parts.



www.eurogasket.com.tr

To fit VOLVO

CYLINDER HEAD GASKET

Engine Model / Description	Eurogasket Part Number	OEM Part Number	Product Picture
VOLVO FH 12 Cylinder Head Gasket (Old Model)	7 017 507	3 093 503 Elring No: 005 100	
VOLVO FH 12 Cylinder Head Gasket (New Model)	7 011 900	3 099 100 Elring No: 115 151	
VOLVO FH 16 Cylinder Head Gasket	834 186	276 924 Elring No: 461 710	

Disclaimer: OEM numbers are for reference only and do not imply that they are originals parts.



www.eurogasket.com.tr

To fit VOLVO

OIL PAN GASKET

Engine Model / Description	Eurogasket Part Number	OEM Part Number	Product Picture
VOLVO TD 60 – 61 VOLVO D50A Oil Pan Gasket	686 400-5	424 600	
VOLVO TD 70 – 71 VOLVO D70 Oil Pan Gasket	686 191	424 919 Elring No: 759 390	
VOLVO TD 100 – 101 - 102 Oil Pan Gasket	686 408-9	424 602 Elring No: 477 020	
VOLVO TD 120-121 - 122-123 Oil Pan Gasket	632 505-9 686 405-6	478 505-1 424 605-4 Elring No: 749 487	
VOLVO FH 12C Oil Pan Gasket	860 093-6	240 017-4	

Disclaimer: OEM numbers are for reference only and do not imply that they are originals parts.



www.eurogasket.com.tr

To fit VOLVO

OIL PAN GASKET

Engine Model / Description	Eurogasket Part Number	OEM Part Number	Product Picture
VOLVO D12 A-B 12A VOLVO FH 12A Oil Pan Gasket	9 563 548	1 547 562	
VOLVO D13 A/B Oil Pan Gasket Oil Pan Gasket (For Steel & Aluminium Oil Pan)	8 056 9160 8 059 5229	2 054 1940 2 051 5881	
VOLVO D16 Oil Pan Gasket	9 554 723	1 556 387 Elring No: 395 440	
VOLVO TD 162 - 163 Oil Pan Gasket	9 567 511	1 543 599 Elring No: 473 530	
VOLVO D9A Oil Pan Gasket	8 029 8626	2 081 2484 Elring No: 377 950	

Disclaimer: OEM numbers are for reference only and do not imply that they are originals parts.



www.eurogasket.com.tr

To fit **VOLVO**

VALVE COVER GASKET

Product Details	Product Picture	Product Details	Product Picture
<p>VOLVO TD 60 Valve Cover Gasket</p> <p>OEM No: 270 770-1</p> <p>Eurogasket No: 830 330-9</p> <p>Elring No: 108 074</p>		<p>VOLVO TD 61 Valve Cover Gasket</p> <p>OEM No: 270 762-8</p> <p>Eurogasket No: 830 348-2</p>	
<p>VOLVO TD 70 Valve Cover Gasket</p> <p>OEM No: 270 761-0</p> <p>Eurogasket No: 830 349-0</p> <p>Elring No: 108 066</p>		<p>VOLVO TD 71 Valve Cover Gasket</p> <p>OEM No: 275 781-1 471 520-7</p> <p>Eurogasket No: 835 329-9</p> <p>Elring No: 755 036</p>	
<p>VOLVO TD 100 Valve Cover Gasket</p> <p>OEM No: 423 146-2 423 146-0</p> <p>Eurogasket No: 687 964-8</p> <p>Elring No: 088 153</p>		<p>VOLVO TD 100 Valve Cover Gasket</p> <p>OEM No: 423 145-2</p> <p>Eurogasket No: 687 965-8</p> <p>Elring No: 088 161</p>	
<p>VOLVO TD 101 Valve Cover Gasket</p> <p>OEM No: 424 693-0</p> <p>Eurogasket No: 686 417-0</p> <p>Elring No: 776 476</p>		<p>VOLVO TD 101 Valve Cover Gasket</p> <p>OEM No: 424 694-8</p> <p>Eurogasket No: 686 416-2</p> <p>Elring No: 776 483</p>	
<p>VOLVO TD 120 – 121 -122 Valve Cover Gasket</p> <p>OEM No: 424 692-2</p> <p>Eurogasket No: 686 418-8</p> <p>Elring No: 776 467</p>		<p>VOLVO TD 162-63 Valve Cover Gasket</p> <p>OEM No: 1 543 581</p> <p>Eurogasket No: 9 567 529</p> <p>Elring No: 550 590</p>	

Disclaimer: OEM numbers are for reference only and do not imply that they are originals parts.



www.eurogasket.com.tr

To fit VOLVO

VALVE COVER SET

Engine Model / Description	Eurogasket Part Number	OEM Part Number	Product Picture
VOLVO D50A / D60A Valve Cover Set	830 330	270 770	
VOLVO TD60B / TD60C Valve Cover Set	830 348	270 762	
VOLVO TD 61 F-FB Valve Cover Set	835 334	275 776	
VOLVO D70 A-B VOLVO TD 70 Valve Cover Set	830 349	270 761	
VOLVO TD 71 F-FA Valve Cover Set	835 329	275 781	

Disclaimer: OEM numbers are for reference only and do not imply that they are originals parts.



www.eurogasket.com.tr

To fit VOLVO

VALVE COVER SET

Engine Model / Description	Eurogasket Part Number	OEM Part Number	Product Picture
VOLVO D100 A-B VOLVO TD100 B Valve Cover Set	834 076	276 034	
VOLVO TD 100 G-GA VOLVO TD 101 VOLVO TD 102 - 103 Valve Cover Set	834 075	276 035	
VOLVO HD 100A VOLVO THD 100A-DA Valve Cover Set	835 557	275 553	
VOLVO THD 100D-DB THD 101 - 102 - 103 DH 10A Valve Cover Set	835 369	275 741	
VOLVO TD 120 - 121 VOLVO TD 122 - 123 Valve Cover Set	835 556	275 554	

Disclaimer: OEM numbers are for reference only and do not imply that they are originals parts.



www.eurogasket.com.tr

To fit VOLVO

VALVE COVER SET

Engine Model / Description	Eurogasket Part Number	OEM Part Number	Product Picture
VOLVO TD 162 F VOLVO TD 163 ES VOLVO D 16A VOLVO FH 16 Valve Cover Set	834 472	276 638	
VOLVO D12A VOLVO FH12 Valve Cover Gasket	9 533 516	1 577 594	
VOLVO D12C VOLVO D12D Valve Cover Gasket	2 930 994	8 170 116	
VOLVO D13A/B Valve Cover Gasket	80 572 317	20 538 793	
VOLVO D9A/B Valve Cover Gasket	80 206 472 2 962 061	20 804 638 8 148 049	

Disclaimer: OEM numbers are for reference only and do not imply that they are originals parts.



www.eurogasket.com.tr

To fit **VOLVO**

INTAKE MANIFOLD GASKET

Product Details	Product Picture	Product Details	Product Picture
<p>VOLVO TD 50-60 Intake Manifold Gasket</p> <p>OEM No: 424 610-4</p> <p>Eurogasket No: 686 490-6</p> <p>Elring No: 756 288</p>		<p>VOLVO TD 70 Intake Manifold Gasket</p> <p>OEM No: 424 611</p> <p>Eurogasket No: 686 499</p>	
<p>VOLVO TD 100 Intake Manifold Gasket</p> <p>OEM No: 402 185-3</p> <p>Eurogasket No: 608 925-7</p>		<p>VOLVO TD 101 Intake Manifold Gasket</p> <p>OEM No: 469 829-6</p> <p>Eurogasket No: 641 281-4</p> <p>Elring No: 570 516</p>	
<p>VOLVO TD 120-121-122 Intake Manifold Gasket</p> <p>OEM No: 423 174-2</p> <p>Eurogasket No: 687 936-8</p> <p>Elring No: 088 056</p>		<p>VOLVO D12C Intake Manifold Gasket</p> <p>OEM No: 20 463 858</p> <p>Eurogasket No: 80 647 252</p>	
<p>VOLVO D13A/B Intake Manifold Gasket</p> <p>OEM No: 20 805 850</p> <p>Eurogasket No: 80 205 250</p> <p>Elring No: 038 630</p>			

Disclaimer: OEM numbers are for reference only and do not imply that they are originals parts.



www.eurogasket.com.tr

To fit **VOLVO**

EXHAUST MANIFOLD GASKET

Product Details	Product Picture	Product Details	Product Picture
<p>VOLVO TD 50-60 Exhaust Manifold Gasket</p> <p>OEM No: 420 708-0</p> <p>Eurogasket No: 680 302-0</p>		<p>VOLVO TD 61 Exhaust Manifold Gasket</p> <p>OEM No: 420 538-1</p> <p>Eurogasket No: 680 572-9</p>	
<p>VOLVO TD 70 Exhaust Manifold Gasket</p> <p>OEM No: 421 534-9</p> <p>Eurogasket No: 689 576-1</p> <p>Elring No: 693 731</p>		<p>VOLVO TD 71 Exhaust Manifold Gasket</p> <p>OEM No: 471 650-2</p> <p>Eurogasket No: 639 450-8</p>	
<p>VOLVO TD 100 Exhaust Manifold Gasket</p> <p>OEM No: 424 634-4</p> <p>Eurogasket No: 686 476-6</p> <p>Elring No: 756 164</p>		<p>VOLVO TD 101-102 Exhaust Manifold Gasket</p> <p>OEM No: 479 107-5</p> <p>Eurogasket No: 631 903-5</p> <p>Elring No: 834 238</p>	
<p>VOLVO TD 120-121-122-123 Exhaust Manifold Gasket</p> <p>OEM No: 470 534-9</p> <p>Eurogasket No: 630 576-1</p> <p>Elring No: 527 319</p>		<p>VOLVO FH 12 VOLVO D12A Exhaust Manifold Gasket</p> <p>OEM No: 8 170 959</p> <p>Eurogasket No: 2 930 151</p>	
<p>VOLVO TD 162F-FL VOLVO D16A VOLVO FH 16 Exhaust Manifold Gasket</p> <p>OEM No: 154 385-8</p> <p>Eurogasket No: 956 725-2</p>		<p>VOLVO D16 Exhaust Manifold Gasket</p> <p>OEM No: 207 44 865</p> <p>Eurogasket No: 803 66 245</p>	

Disclaimer: OEM numbers are for reference only and do not imply that they are originals parts.



www.eurogasket.com.tr

To fit VOLVO

EXHAUST MANIFOLD GASKET

Product Details		Product Picture	
<p>VOLVO D9 Exhaust Manifold Gasket</p> <p>OEM No: 814 8172</p> <p>Eurogasket No: 296 2938</p> <p>Elring No: 398 340</p>		<p>VOLVO D13 Exhaust Manifold Gasket</p> <p>OEM No: 205 43071</p> <p>Eurogasket No: 805 67039</p> <p>Elring No: 005 720</p>	

Disclaimer: OEM numbers are for reference only and do not imply that they are originals parts.



www.eurogasket.com.tr

To fit VOLVO

EXHAUST GASKET SET

Engine Model / Description	Eurogasket Part Number	OEM Part Number	Product Picture
VOLVO D50A-B VOLVO TD50A-B Exhaust Gasket Set	830 344	270 766	
VOLVO D60A VOLVO TD60A Exhaust Gasket Set	830 341	270 769	
VOLVO TD60A VOLVO TD60B-C Exhaust Gasket Set	830 342	270 768	
VOLVO TD61 F-FB VOLVO TD63 VOLVO D6A Exhaust Gasket Set	830 346	270 764	
VOLVO D70A-B VOLVO TD70A VOLVO TD70C Exhaust Gasket Set	830 339	270 771	

Disclaimer: OEM numbers are for reference only and do not imply that they are originals parts.



www.eurogasket.com.tr

To fit VOLVO

EXHAUST GASKET SET

Engine Model / Description	Eurogasket Part Number	OEM Part Number	Product Picture
VOLVO TD 71 F-FA VOLVO TD 71 FD Exhaust Gasket Set	830 345	270 765	
VOLVO D100 A-B VOLVO THD 100 A-D Exhaust Gasket Set	830 152	270 958	
VOLVO TD 100 G-GA VOLVO THD 100 EA VOLVO TD 101-102-103 Exhaust Gasket Set	834 058	276 052	
VOLVO TD 120-121-122-123 Exhaust Gasket Set	830 338	270 772	
VOLVO TD 162 F-FS VOLVO TD 163 FL VOLVO FH 16 Exhaust Gasket Set	839 022	271 088	

Disclaimer: OEM numbers are for reference only and do not imply that they are originals parts.



www.eurogasket.com.tr

To fit VOLVO

EXHAUST GASKET SET

Engine Model / Description	Eurogasket Part Number	OEM Part Number	Product Picture
VOLVO FH12 Exhaust Gasket Set	834 170	276 930	

Disclaimer: OEM numbers are for reference only and do not imply that they are originals parts.



www.eurogasket.com.tr

To fit **VOLVO**

TURBO GASKET

Product Details	Product Picture	Product Details	Product Picture
<p>VOLVO TD 100A – 101A – 120A VOLVO FH 12 Turbo Gasket</p> <p>OEM No: 270 758-6</p> <p>Eurogasket No: 830 352-4</p> <p>Erling No: 597 075</p>		<p>VOLVO D9-11-13 Turbo Gasket</p> <p>OEM No: 207 81146</p> <p>Eurogasket No: 803 29964</p> <p>Elring No: 409 330</p>	
<p>VOLVO D9A D12C/D – D16C Turbo Gasket</p> <p>OEM No: 470 939</p> <p>Eurogasket No: 630 171</p>		<p>VOLVO D9A D12C/D – D16C Turbo Gasket (New Version)</p> <p>OEM No: 207 84537</p> <p>Eurogasket No: 803 26573</p>	
<p>VOLVO (All Models) Turbo Gasket</p> <p>OEM No: 420 643</p> <p>Eurogasket No: 680 467</p> <p>Elring No: 753 262</p>		<p>VOLVO D13A Turbo Gasket</p> <p>OEM No: 208 41816</p> <p>Eurogasket No: 802 69294</p>	
<p>VOLVO D13A Turbo Gasket</p> <p>OEM No: 208 50815</p> <p>Eurogasket No: 802 50295</p>		<p>VOLVO TD 100-101 Turbo Gasket Set</p> <p>OEM No: 276 815</p> <p>Eurogasket No: 834 295</p>	
<p>VOLVO TD 100A/B/BG Turbo Gasket Set</p> <p>OEM No: 270 767</p> <p>Eurogasket No: 830 343</p>		<p>VOLVO TD 100A/B Turbo Gasket Set</p> <p>OEM No: 270 997</p> <p>Eurogasket No: 830 113</p>	

Disclaimer: OEM numbers are for reference only and do not imply that they are originals parts.



www.eurogasket.com.tr

To fit VOLVO

TURBO GASKET

Product Details		Product Picture	
<p>VOLVO D16A FH16 Turbo Gasket Set</p> <p>OEM No: 276 640</p> <p>Eurogasket No: 834 460</p>		<p>VOLVO D12A Turbo Gasket Set</p> <p>OEM No: 276 807</p> <p>Eurogasket No: 834 203</p>	
<p>VOLVO TD60 A-B Turbo Gasket Metal</p> <p>OEM No: 465 119-6</p> <p>Eurogasket No: 645 991-4</p>			

Disclaimer: OEM numbers are for reference only and do not imply that they are originals parts.



www.eurogasket.com.tr

To fit VOLVO

GASKET

Product Details	Product Picture	Product Details	Product Picture
<p>VOLVO FH12 – TD60 – TD61 – TD70 – TD71 Gasket</p> <p>OEM No: 420 223</p> <p>Eurogasket No: 680 887</p>		<p>VOLVO FH12 – TD60 – TD61 – TD70 – TD71 Gasket</p> <p>OEM No: 465 786</p> <p>Eurogasket No: 645 324</p>	
<p>VOLVO FH 12 Gasket</p> <p>OEM No: 205 55 359</p> <p>Eurogasket No: 805 55 751</p>		<p>VOLVO TD 120-121-122 Gasket</p> <p>OEM No: 424 618-7</p> <p>Eurogasket No: 686 492-3</p>	
<p>VOLVO TD 100-101-102-120-121-122 Gasket</p> <p>OEM No: 469 823-9</p> <p>Eurogasket No: 641 287-1</p>		<p>VOLVO TD 101-120-121-122 Gasket</p> <p>OEM No: 420 226</p> <p>Eurogasket No: 680 884</p>	
<p>VOLVO TD 100-101-102 Gasket</p> <p>OEM No: 420 220</p> <p>Eurogasket No: 680 880</p>		<p>VOLVO TD 120-121-122 Gasket</p> <p>OEM No: 423 277</p> <p>Eurogasket No: 687 833</p>	
<p>VOLVO TD 100-101-120-121-122 Gasket</p> <p>OEM No: 422 283</p> <p>Eurogasket No: 688 827</p>		<p>VOLVO TD 61-71 Gasket</p> <p>OEM No: 420 160</p> <p>Eurogasket No: 680 940</p>	

Disclaimer: OEM numbers are for reference only and do not imply that they are originals parts.



www.eurogasket.com.tr

To fit VOLVO

GASKET

Product Details	Product Picture	Product Details	Product Picture
<p>VOLVO TD100-103 VOLVO TD120-122 Cylinder Block Gasket</p> <p>OEM No: 469 823</p> <p>Eurogasket No: 641 287</p>		<p>VOLVO D12A/B/C/D Cylinder Block Gasket</p> <p>OEM No: 1 677 656</p> <p>Eurogasket No: 9 433 454</p> <p>Elring No: 355 980</p>	
<p>VOLVO D13A/B Cylinder Block Gasket</p> <p>OEM No: 2 097 9871</p> <p>Eurogasket No: 8 013 1239</p>		<p>VOLVO D12 TURBO C Gasket Rubber</p> <p>OEM No: 2 0532 272</p> <p>Eurogasket No: 8 0578 838</p>	
<p>VOLVO D13-D16 FH12-16 FM12 Gasket Crankcase Ventilation</p> <p>OEM No: 20 532 891</p> <p>Eurogasket No: 80 578 219</p>		<p>VOLVO D13 FH13 FM13 Gasket Crankcase Ventilation</p> <p>OEM No: 20 777 888</p> <p>Eurogasket No: 80 333 222</p>	
<p>VOLVO FH12 Thermostat Gasket</p> <p>OEM No: 8 170 519</p> <p>Eurogasket No: 2 930 591</p> <p>Elring No: 257 880</p>		<p>VOLVO FH12 Cooling Flange Gasket</p> <p>OEM No: 8 170 515</p> <p>Eurogasket No: 2 930 595</p> <p>Elring No: 390 360</p>	

Disclaimer: OEM numbers are for reference only and do not imply that they are originals parts.



www.eurogasket.com.tr

To fit VOLVO

GASKET

Product Details		Product Picture	
VOLVO TD60-70-100 Gasket Rubber OEM No: 469 120 Eurogasket No: 641 980 Elring No: 813 761		VOLVO TD100-101-102- 120-121-122 Gasket Rubber OEM No: 422 418 Eurogasket No: 688 692 Elring No: 813 737	
VOLVO TD61-71 VOLVO FH12 Gasket Rubber OEM No: Eurogasket No:		VOLVO TD120-121-122 Gasket Rubber OEM No: 469 121 Eurogasket No: 641 989	
VOLVO TD50-60-61-70- 71-72-73-100-101-102- 103-120-121-122 Gasket Rubber OEM No: 469 122 Eurogasket No: 641 988		VOLVO TD61-71 VOLVO FH12 Gasket Rubber OEM No: Eurogasket No:	
VOLVO TD50-60-70 Seal OEM No: 421 147-0 Eurogasket No: 689 963-0 Elring No: 104 760		VOLVO TD50-60-70 Seal OEM No: 421 131-4 Eurogasket No: 689 979-6 Elring No: 104 752	

Disclaimer: OEM numbers are for reference only and do not imply that they are originals parts.



www.eurogasket.com.tr

To fit VOLVO

GASKET

Product Details		Product Picture	
<p>VOLVO Tribune Inlet Gasket</p> <p>OEM No: 469 662</p> <p>Eurogasket No: 641 448</p>			



Disclaimer: OEM numbers are for reference only and do not imply that they are originals parts.



www.eurogasket.com.tr

To fit VOLVO

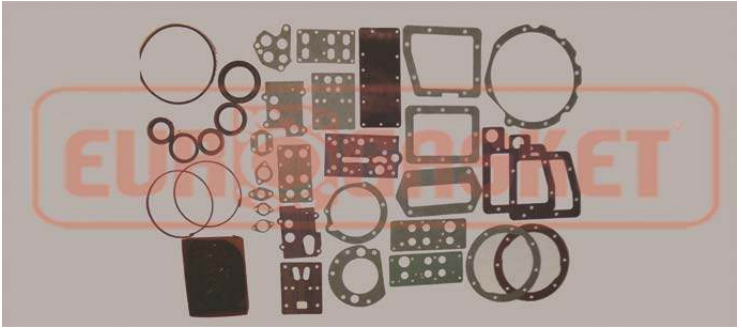
GEAR SET

Engine Model / Description	Eurogasket Part Number	OEM Part Number	Product Picture
VOLVO 4300-4300B VOLVO 4400-4500 HT 100-120 Gear Set	991 10 903	119 90 107	
VOLVO L90 VOLVO L90CB / L 120 HT 130-131-132 Gear Set	991 100 15-1	119 900 95-9	

Disclaimer: OEM numbers are for reference only and do not imply that they are originals parts.



www.eurogasket.com.tr

To fit VOLVO

SHIM

Engine Model / Description	Eurogasket Part Number	OEM Part Number	Product Picture
VOLVO D100 TD100-101-102-103 THD101-102-103-104 SHIM Shim 0,20 mm Shim 0,30 mm Shim 0,50 mm	688 491-3 688 480-5 688 489-7	422 619-7 422 620-5 422 621-3	
VOLVO D70 TD70-71-73 SHIM Shim 0,20 mm Shim 0,30 mm Shim 0,50 mm	644 996-4 644 927-9 644 926-1	466 114-6 466 183-1 466 184-9	
VOLVO D60 TD60-61-63 SHIM Shim 0,20 mm Shim 0,30 mm Shim 0,50 mm	645 716-5 645 715-8 645 714-0	465 394-5 465 395-2 465 396-0	
VOLVO TD120-121-122-123 SHIM Shim 0,20 mm Shim 0,30 mm Shim 0,50 mm	642 839-8 642 838-0 642 837-2	468 271-2 468 272-0 468 273-8	

Disclaimer: OEM numbers are for reference only and do not imply that they are originals parts.



www.eurogasket.com.tr

To fit **VOLVO**

RUBBER

Product Details	Product Picture	Product Details	Product Picture
<p>VOLVO D50A-TD50A-TD50B Rubber Kit</p> <p>OEM No: 275 460-4</p> <p>Eurogasket No: 835 640-6</p> <p>2 Pcs 106,5 x 5,70 EPDM 1 Pcs 103,5 x 1,60FPM Green</p>		<p>VOLVO D60A-TD60A-TD60B-TD60C Rubber Kit</p> <p>OEM No: 271 162-0</p> <p>Eurogasket No: 839 948-0</p> <p>1 Pc 108,5 x 5,8 FPM Black 1 Pc 108,5 x 5,8 FPM Purple 1 Pc 105,5 x 1,6 FPM Black</p>	
<p>VOLVO TD61F-FBQ-FHQ-G-GA-GB-GC-GE-GS TD63E-TD63ES Rubber Kit</p> <p>OEM No: 271 161-2</p> <p>Eurogasket No: 839 949-8</p> <p>2 Pcs 108,5 x 5,8 FPM Black 1 Pc 108,5 x 5,8 FPM Purple 1 Pc 105,5 x 1,6 FPM Black</p>		<p>VOLVO D70A-B TD70 Rubber Kit</p> <p>OEM No: 271 160-4</p> <p>Eurogasket No: 839 940-6</p> <p>1 Pc 115,8 x 5,8 FPM Black 1 Pc 115,8 x 5,8 FPM Purple 1 Pc 114 x 1,6 FPM Black</p>	
<p>VOLVO TD71 TD73 Rubber Kit</p> <p>OEM No: 271 160-4</p> <p>Eurogasket No: 839 940-6</p> <p>2 Pcs 115,8 x 5,8 FPM Black 1 Pc 115,8 x 5,8 FPM Purple 1 Pc 114 x 1,6 FPM Black</p>		<p>VOLVO D100A-B THD100A – TD 101F Rubber Kit</p> <p>OEM No: 271 158-8</p> <p>Eurogasket No: 839 952-2</p> <p>1 Pc 132,5 x 1,6 FPM Black 1 Pc 132,7 x 5,7 FPM Purple 1 Pc 132,7 x 5,7 FPM Black</p>	
<p>VOLVO THD101 TD103 – TD 101F Rubber Kit</p> <p>OEM No: 271 157-0</p> <p>Eurogasket No: 839 953-0</p> <p>1 Pc 132,5 x 2,4 FPM Black 1 Pc 133,8 x 5,7 FPM Purple 1 Pc 133,8 x 5,7 FPM Black</p>		<p>VOLVO TD120A Rubber Kit</p> <p>OEM No: 271 181-0</p> <p>Eurogasket No: 839 929-0</p> <p>1 Pc 143,5 x 1,6 FPM Black 1 Pc 142,8 x 5,8 FPM Purple 1 Pc 142,8 x 5,8 FPM Black</p>	
<p>VOLVO TD120C-D-E-F-FA-FB-FC-G-GA Rubber Kit</p> <p>OEM No: 271 156-2</p> <p>Eurogasket No: 839 954-8</p> <p>1 Pc 143,5 x 1,6 FPM Black 1 Pc 142,8 x 5,8 FPM Purple 1 Pc 142,8 x 5,8 FPM Black 1 Pc Volvo 468 582-1</p>		<p>VOLVO TD121F TD121 FK Rubber Kit</p> <p>OEM No: 271 155-4</p> <p>Eurogasket No: 839 955-6</p> <p>1 Pc 143,5 x 1,6 FPM Black 1 Pc 142,8 x 5,8 FPM Purple 2 Pcs 142,8 x 5,8 FPM Black</p>	



Disclaimer: OEM numbers are for reference only and do not imply that they are originals parts.



www.eurogasket.com.tr

To fit VOLVO

RUBBER

Product Details		Product Picture	
<p>VOLVO TD121 FK TD122F Rubber Kit</p> <p>OEM No: 270 950-9</p> <p>Eurogasket No: 830 150-1</p> <p>2 Pcs 142,8 x 5,8 FPM Black 1 Pc 142,8 x 5,8 FPM Purple 2 Pcs 140 x 2,5 FPM Black</p>		<p>VOLVO D16A-TD162F Rubber Kit</p> <p>OEM No: 270 950-9</p> <p>Eurogasket No: 830 150-1</p> <p>1 Pc 169 x 2,4 FPM Purple 1 Pc 155 x 2,5 EPDM 2 Pcs 157,6 x 5,8 FPM Black 1 Pc 157,6 x 5,8 FPM Purple</p>	

Disclaimer: OEM numbers are for reference only and do not imply that they are originals parts.



www.eurogasket.com.tr

SEALS – To Fit VOLVO



OEM Part Number	DPH Part Number	Etring Part Number	Corteco Part Number	Application	Dimensions
1 076 656-6	111456			Wheel Acs. Kit	100 x 113,6 x 6,5 NBR
1 089 552	117745	522911	12014742	Front Wheel Hub	110 x 140 x 12/19 FPM
1 139 840	95872			Gear Box	85 x 105 x 12/10 NBR
1 190 064	4047			Gear Box	85 x 105 x 10 FPM
1 276 425	16052	465194	15012624	Crankshaft	52 x 68 x 10 MVQ
1 521 431	112981	435820	01030098	Gear Box	64,9 x 90 x 9,5/10 FPM
1 522 372	50173	922277	12014656	Rear Axle	140 x 164 x 20/23,5 FPM
1 522 373	80492	597015	20019176	Rear Axle	50 x 65 x 8 FPM
1 522 894	69292	58808	12014744	Differential Carrier	80 x 150 x 12/20 FPM
1 522 895	69294			Automotic Gearbox	80 x 130,2 x 12/20 ACM
1 522 895	82426	588016	12014745	Automotic Gearbox	80 x 130,2 x 12/20 FPM
1 522 896	95891	590738	12011324	Crankshaft	150 x 180 x 17,5/16 FPM
1 523 239	94049	435180	12015693	Differential	90 x 145 x 10/15 FPM
1 523 634	119116			Differential	90 x 151 x 11/17 FPM
1 524 281	95893		12016843	Crankshaft	150 x 180 x 10 STEEL
1 524 838	112987		12013988	Crankshaft	70 x 102 x 14,5 FPM
1 526 008	114355		01030336	Crankshaft	54,5 x 80 x 8 FPM
1 526 688	36792			Crankshaft	55 x 75 x 8 FPM
1 526 828	95476			Crankshaft	105 x 130 x 12/9,5 ACM
1 543 896	108818		12015255	Crankshaft	180 x 205 x 15 FPM
1 543 908-6	120475		12017220	Ret. Water Pump	80 x 100 x 10 ACM
1 543 936	114337		12017221	Crankshaft	45 x 65 x 8 ACM
1 546 221	114332	760240	12017218	Injection Pump	34,9 x 62 x 8 ACM
1 546 480	114336	390010	01030097	Crankshaft	45 x 62 x 8 ACM
1 549 398	112984				136 x 159 x 13 PTFE/ACM
1 577 624	36376		12011387	Wheel Hub	133,35 x 155,6 x 14 NBR
1 587 792	82425	522910	12013870	Front Axle	110 x 140 x 12/21 NBR
1 591 903	50796	522880	12014351	Wheel Hub	164,4/168 x 188/190 x 30/32 ACM
1 593 459	113947		01015141	Wheel Hub	100 x 140 x 15,5/20 FPM
1 594 257	95207			Wheel Hub	145 x 175 x 17 FPM
1 610 078	82906		12013127	Wheel Hub	77 x 98,4/103 x 6,3/19,3 NBR
1 610 765	50796			Wheel Hub	164,4/168 x 188/190 x 30/32 ACM
1 610 765	98433	693162		Wheel Hub	167 x 188/192,5 x 30/32 FPM
1 652 776	112716	435340	12016675	Automatic Gearbox	90 x 145 x 10 FPM
1 668 341	97703		01031088	Crankshaft	130 x 160 x 15 FPM
1 669 618	94047		01026642	Crankshaft	90 x 110 x 11/9,5 FPM
1 672 249	50173	222757	12016932	Rear Axle	140 x 164 x 20/23,5 FPM

Disclaimer: OEM numbers are for reference only and do not imply that they are originals parts.



www.eurogasket.com.tr

SEALS – To Fit VOLVO



OEM Part Number	DPH Part Number	Etring Part Number	Corteco Part Number	Application	Dimensions
1 673 701	94049	435180	01034125	Differential	90 x 145 x 10/15 FPM
1 695 593	84162				20 x 40 x 8 FPM
1 696 066	51716		12012064	Front-Rear Axle	120 x 140 x 13 NBR
1 699 171	114457				120 x 146 x 19,56 NBR
1 699 341	114455				110 x 140 x 17 NBR
191 160-1	118913				87,17 x 117,47 x 11,9 NBR
192 600	84590		12011122	Injection Pump	25 x 35 x 7 NBR
192 600-5	18612	246891		Injection Pump	70 x 90 x 10 NBR
20 399 560	111426				125 x 148 x 9/7 FPM
20 441 481	114424		20031153	Crankshaft	180 x 205 x 15 PTFE
20 476 025	112981		01030098	Gear Box	64,9 x 90 x 9,5/10 FPM
20 518 642	111428				125 x 148,3 x 8,1/9,3 FPM
20 832 385	116318		01031695	Crankshaft FM9	110,23 x 145 x 10/12
231 938	48518				130 x 160 x 15 MVQ
240 022	84590	038075	12011122	Injection Pump	25 x 35 x 7 NBR
241 625	19108				16 x 30 x 7 NBR
247 576	35050		12013896	Crankshaft	42 x 62 x 10 ACM
247 597	113977		12018944	Stemco 2110	117,48 x 152,36 x 22 NBR
263 448	116002				26 x 34 x 4,5/7 NBR
267 268	35885	587958	12013360		64,9 x 90 x 10 FPM
267 269	35886	587966	12013361		80 x 100 x 10 FPM
267 316	81817		12013864	Gear Box	60 x 80 x 8/9,5 FPM
3 123 521	93292				145 x 175 x 19 NBR
3 152 027	113571		07016736	Crankshaft	85 x 130 x 17/26 FPM/ACM
3 192 069	119116			Differential	90 x 151 x 11/17 FPM
3 192 615	119114			Differential	90 x 151 x 11/14,5 FPM
3 514 943	6763			Camshaft	30 x 47 x 7 NBR
3 514 943	113644	135150	01500581	Camshaft	30 x 47 x 7 FPM
338 425-2	47303	008427		Steering	25 x 35 x 8 NBR
341 050	47945	006408	12014826	Steering	26 x 37 x 7/8 NBR
346 682-8	113479		12013365	Gear Box	60 x 74 x 10/8 FPM
346 822-0	47952	010804	01002259	Front Axle	10 x 15 x 3 NBR
424 580-9	82254	755087	12014476	Injection Pump	29 x 50 x 10/7 ACM
424 763	93307			Crankshaft	130 x 160 x 15 FPM
424 983-5	15250			Crankshaft	85,73 x 114,45 x 14,29 MVQ
424 983-5	81284	570495	12013988	Crankshaft	85,73 x 114,33 x 13/9,5 FPM
469 336-2	81702	760315	12015806	Crankshaft	155 x 180 x 15 FPM

Disclaimer: OEM numbers are for reference only and do not imply that they are originals parts.



www.eurogasket.com.tr

SEALS – To Fit VOLVO



OEM Part Number	DPH Part Number	Etring Part Number	Corteco Part Number	Application	Dimensions
469 507-8	15250			Crankshaft	85,73 x 114,45 x 14,29 MVQ
469 507-8	81284		12013988	Crankshaft	85,73 x 114,33 x 13/9,5 FPM
471 055-4	94792		12014191	Crankshaft	76,2 x 101,6 x 11,9 FPM
471 055-4	80733			Crankshaft	76,2 x 101,6 x 11,9 MVQ
471 056-2	94791		12013863	Crankshaft	127 x 150 x 12 FPM
471 056-2	50795	518360		Crankshaft	127 x 150 x 12 MVQ
477 118-4	80733			Crankshaft	76,2 x 101,6 x 11,9 MVQ
477 118-4	94792	754669	01016760	Crankshaft	76,2 x 101,6 x 11,9 FPM
477 119-2	50795			Crankshaft	127 x 150 x 12 MVQ
477 119-2	94791	518361	12013863	Crankshaft	127 x 150 x 12 FPM
6 770 964-2	113749		12013365	Gear Box	60 x 74 x 10/8 FPM
6 771 541-7	95388			Crankshaft	135 x 165 x 17 NBR
6 797 452-7	114374		12014424	Gear Box	65 x 85 x 13 FPM
6 857 279-1	81637	040991	12011331	Gear Box	48 x 65 x 10 NBR
6 876 126-1	47988		12011306	Gear Box	48 x 69 x 10 FPM
6 876 127-9	81637	040991	12011331	Gear Box	48 x 65 x 10 NBR
6 876 131-1	47944		12014736	Gear Box	70 x 90 x 10 FPM
6 876 132-9	18611		12011015	Gear Box	70 x 90 x 10 NBR
6 876 142-8	4378			Gear Box	25 x 35 x 7 NBR
6 876 348-1	4378	038083	12014616	Gear Box	25 x 35 x 7 NBR
6 877 226-8	95622		01031231	Differential	47,62 x 80,26 6,8/13,3 FPM
6 877 944-6	114367		01030337	Crankshaft	63,5 x 102,5 x 6,6/14,8 FPM
8 148 259	112978	515800			150 x 180 x 15 PTFE/ACM
821 755-6	81702	760315	12015806	Crankshaft	155 x 180 x 15 FPM
943 250-1	69288				63,5 x 110 x 12 FPM
943 704-7	35886	587966	12013361	PB 269	80 x 100 x 10 FPM
943 741-9	94045	246905	01027966		26,3 x 36,2 x 7,3 NBR
944 665-9	80880	522864	12011389	Rear Axle	148 x 168/170 x 32 NBR
944 666-7	50796	522880	12014351	Wheel Hub	164,4/168 x 188/190 x 30/32 ACM
944 667-5	36376	522856	12011387	Wheel Hub	133,3 x 155,6 x 14 NBR
944 670-9	61171			Rear Axle	126,5 x 148 x 14,7 METAL
944 671-7	119900			Front-Rear Axle	126,75 x 168 x 15 NBR
945 538-7	51729			Balance Arm Bogie	180 x 224 x 12 NBR
946 026-2	80012	694088		Front-Rear Axle	152,4 x 120,65 x 13/12 NBR
946 093-2	18911	108626	12011367	Wheel Hub	125 x 150 x 13 NBR
947 269-7	113981	043737	07013486	Wheel Acss. Kit	80 x 95 x 8 NBR
947 270-5	81336	300896	12013388	Wheel Acss. Kit	85 x 110 x 13/9,5

Disclaimer: OEM numbers are for reference only and do not imply that they are originals parts.

Gearbox Gasket

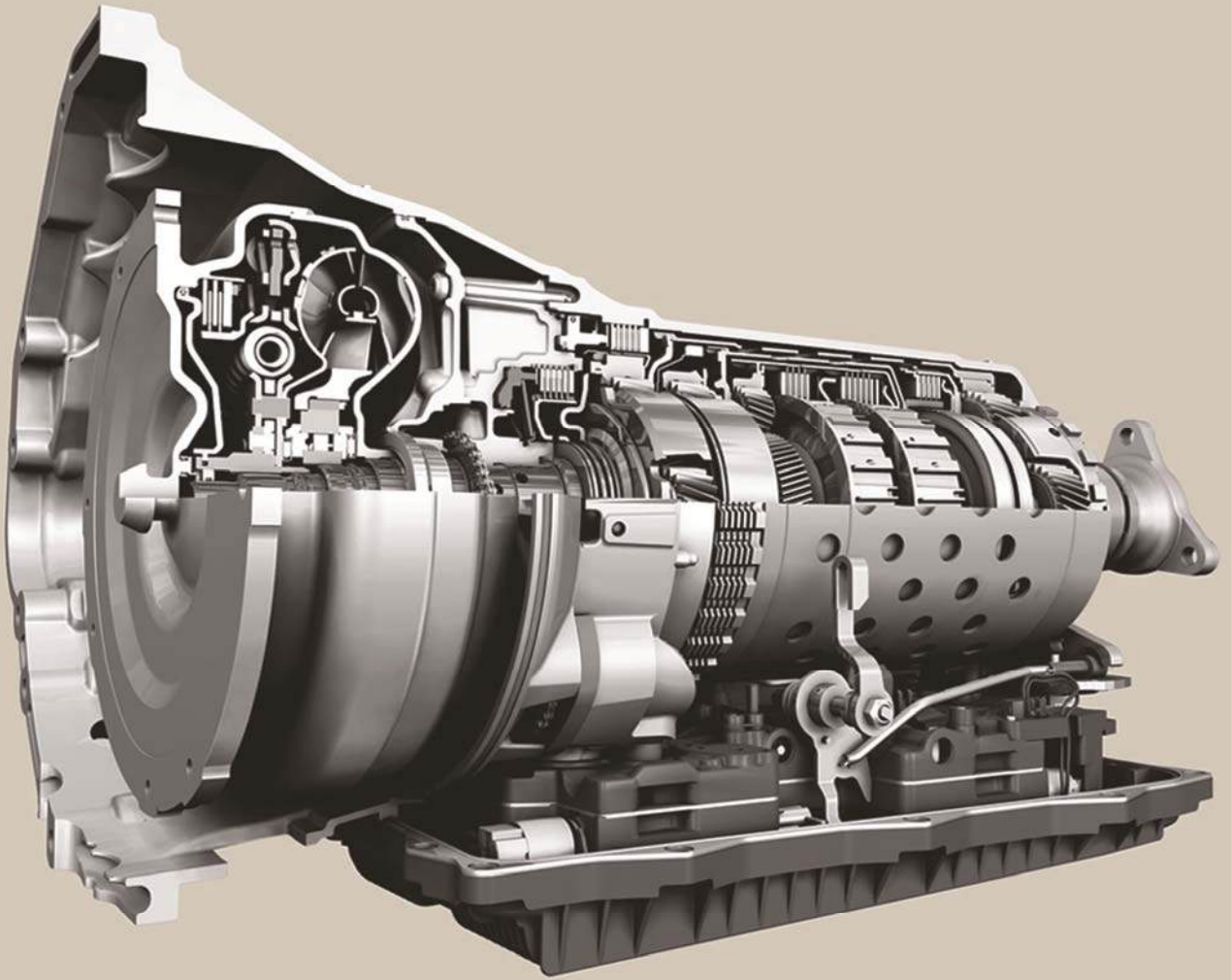

to fit- ZF



www.eurogasket.com.tr

To fit ZF

GEAR BOX GASKET

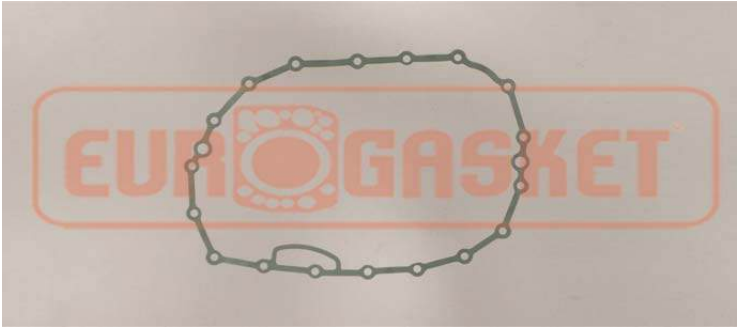
Engine Model / Description	Eurogasket Part Number	OEM Part Number	Product Picture
ZF Gear Box Gasket			

Disclaimer: OEM numbers are for reference only and do not imply that they are originals parts.



www.eurogasket.com.tr

To fit ZF

GEAR BOX GASKET

Engine Model / Description	Eurogasket Part Number	OEM Part Number	Product Picture
ZF Gear Box Gasket	981 070 9960	129 030 1140	
ZF Gear Box Gasket	978 6703 028	132 4307 082	
ZF Gear Box Gasket	0509 886 484	0501 224 626	
ZF Gear Box Gasket	9842 703 930	1268 307 170	

Disclaimer: OEM numbers are for reference only and do not imply that they are originals parts.



www.eurogasket.com.tr

To fit ZF

GEAR BOX GASKET

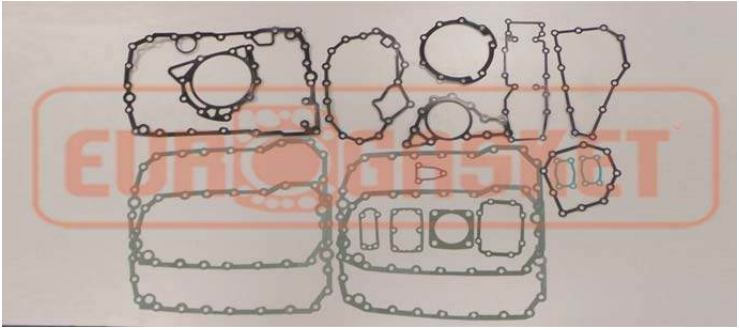
Engine Model / Description	Eurogasket Part Number	OEM Part Number	Product Picture
ZF Gear Box Gasket	9795 812 009	1315 298 001	

Disclaimer: OEM numbers are for reference only and do not imply that they are originals parts.

COMPRESSOR GASKET

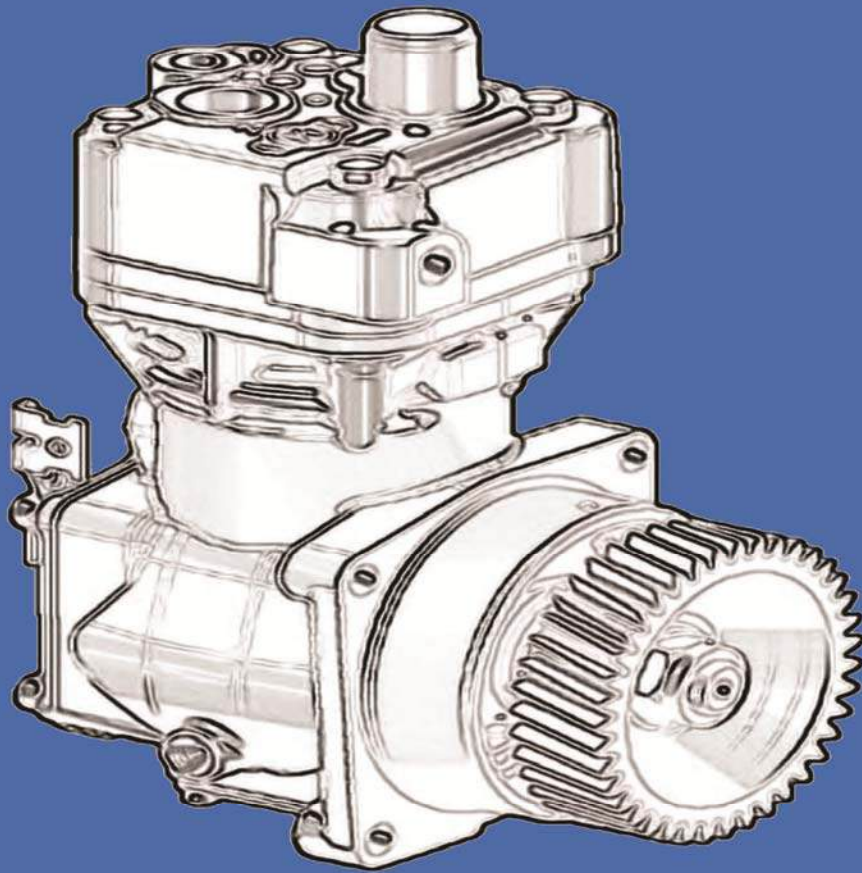

to fit

**DAF-IVECO-MAN-MERCEDES
RENAULT RVI-SCANIA-VOLVO**



www.eurogasket.com.tr

COMPRESSOR GASKET | To Fit – DAF

Compressor OEM No : 1 320 400 / 1 328 480

Type / Engine	Eurogasket Part Number	OEM Part Number	Product Picture
<p>DB 250 F 2100 Repair Kit Full</p>	<p>907 5004 900</p>		
<p>DB 250 F 2100 Repair Kit</p>	<p>907 5004 800</p>		
<p>DB 250 F 2100 Gasket Kit</p>	<p>907 5004 890</p>		
<p>DB 250 F 2100 Valve Kit</p>	<p>065 600 997</p>		

Disclaimer: OEM numbers are for reference only and do not imply that they are originals parts.



www.eurogasket.com.tr

COMPRESSOR GASKET | To Fit – DAF

Compressor OEM No : 1 505 917 / 412 704 0010

Type / Engine	Eurogasket Part Number	OEM Part Number	Product Picture
Repair Kit Full	907 5005 900		
Repair Kit	907 5005 800		
Gasket Kit	907 5005 890		
Valve Kit	065 600 909		

Disclaimer: OEM numbers are for reference only and do not imply that they are originals parts.



www.eurogasket.com.tr

COMPRESSOR GASKET | To Fit – DAF

Compressor OEM No : 1 287 663

Type / Engine	Eurogasket Part Number	OEM Part Number	Product Picture
SB 3000 SBG 220 Repair Kit Full	907 5006 900		
SB 3000 SBG 220 Repair Kit	907 5006 800		
SB 3000 SBG 220 Gasket Kit	907 5006 890		
SB 3000 SBG 220 Valve Kit	065 600 971		

Disclaimer: OEM numbers are for reference only and do not imply that they are originals parts.



www.eurogasket.com.tr

COMPRESSOR GASKET | To Fit – DAF

Compressor OEM No : 1 506 365

Type / Engine	Eurogasket Part Number	OEM Part Number	Product Picture
2800 ATI 3300 ATI 3600 ATI Repair Kit Full	907 5007 900		
2800 ATI 3300 ATI 3600 ATI Repair Kit	907 5007 800		
2800 ATI 3300 ATI 3600 ATI Gasket Kit	907 5007 890		
2800 ATI 3300 ATI 3600 ATI Valve Kit	065 600 905		

Disclaimer: OEM numbers are for reference only and do not imply that they are originals parts.



www.eurogasket.com.tr

COMPRESSOR GASKET | To Fit – DAF

Compressor OEM No : 1 282 723

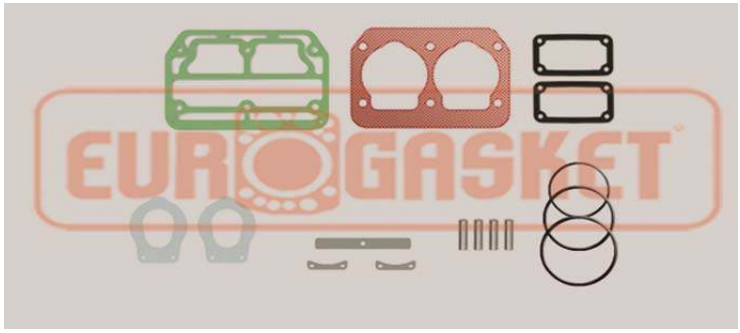
Type / Engine	Eurogasket Part Number	OEM Part Number	Product Picture
865 AVM 1160 AVM Repair Kit Full	907 5008 900		
865 AVM 1160 AVM Repair Kit	907 5008 800		
865 AVM 1160 AVM Gasket Kit	907 5008 890		
865 AVM 1160 AVM Valve Kit	065 600 979		



Disclaimer: OEM numbers are for reference only and do not imply that they are originals parts.



www.eurogasket.com.tr

COMPRESSOR GASKET | To Fit – DAF

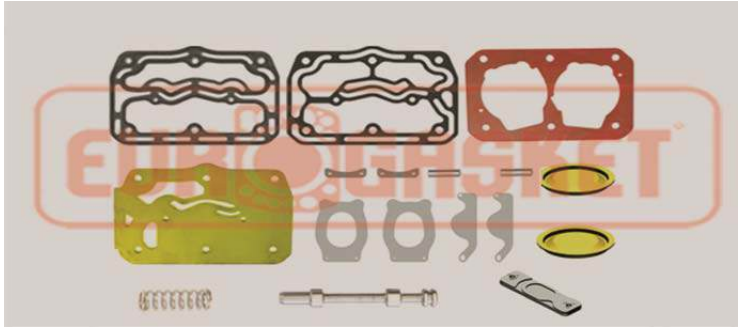
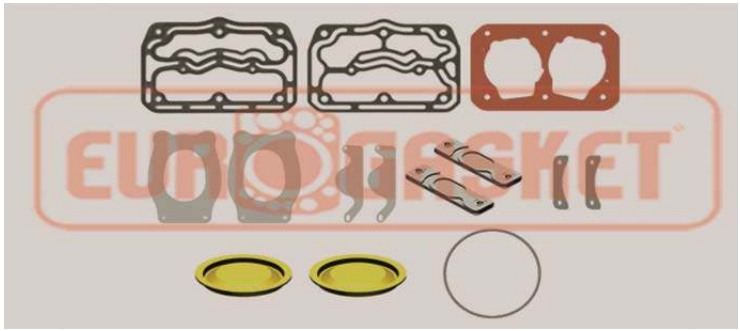
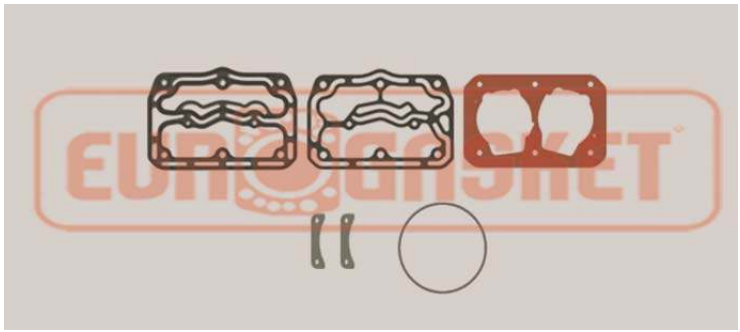
Compressor OEM No : 1 737 654 / 412 442 0000
412 442 0010

Type / Engine	Eurogasket Part Number	OEM Part Number	Product Picture
85 CF 75 CF Repair Kit Full	907 5009 900		
85 CF 75 CF Repair Kit	907 5009 800		
85 CF 75 CF Gasket Kit	907 5009 890		
85 CF 75 CF Valve Kit	065 600 966		

Disclaimer: OEM numbers are for reference only and do not imply that they are originals parts.



www.eurogasket.com.tr

COMPRESSOR GASKET | To Fit – DAF

Compressor OEM No : 1 331 146

Type / Engine	Eurogasket Part Number	OEM Part Number	Product Picture
95 XF CF 75 CF 8 F 75 F 95 Repair Kit	907 5000 800		
95 XF CF 75 CF 8 F 75 F 95 Gasket Kit	907 5000 890		
95 XF CF 75 CF 8 F 75 F 95 Valve Kit	065 600 966		

Disclaimer: OEM numbers are for reference only and do not imply that they are originals parts.



www.eurogasket.com.tr

COMPRESSOR GASKET | To Fit – IVECO

Type / Engine	Eurogasket Part Number	Compressor OEM Number	Product Picture
TURBOCITY EUROCARGO Repair Kit	991 5000 900	98465003 4850697	
EUROTECH EUROSTAR STARLIS Repair Kit	991 5009 800	412112129	
TURBOSTAR Repair Kit	991 5008 010	9316153	
175 190 240 260 Repair Kit	991 5007 800	79073083	
697 619 684 Repair Kit	991 5006 800	76623201	

Disclaimer: OEM numbers are for reference only and do not imply that they are originals parts.



www.eurogasket.com.tr

COMPRESSOR GASKET | To Fit – IVECO

Type / Engine	Eurogasket Part Number	Compressor OEM Number	Product Picture
EUROCARGO MP 190 MP 260 Repair Kit	991 5005 900	4860565	
TECTOR Repair Kit	991 5004 900	4897301 504016818	
TECTOR Repair Kit	991 5003 900		
STARLIS TRAKER Repair Kit	991 5001 900	41211122 1194410 K00821 K002140	
STARLIS TRAKER Repair Kit	991 5090 900	504022988	

Disclaimer: OEM numbers are for reference only and do not imply that they are originals parts.



www.eurogasket.com.tr

COMPRESSOR GASKET | To Fit – IVECO

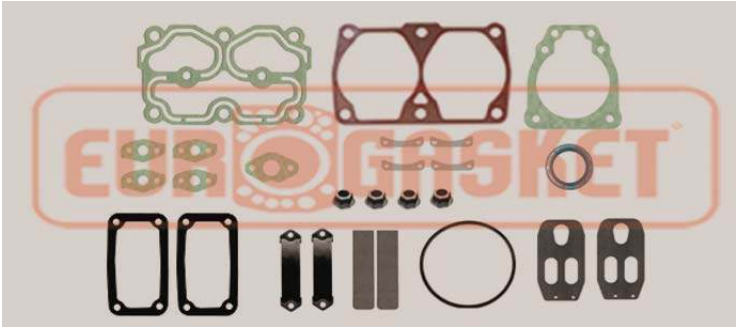
Type / Engine	Eurogasket Part Number	Compressor OEM Number	Product Picture
TURBOCITY EUROTECH Repair Kit	991 5099 900	98465003 98421120	

Disclaimer: OEM numbers are for reference only and do not imply that they are originals parts.



www.eurogasket.com.tr

COMPRESSOR GASKET | To Fit – MAN

Compressor Gasket For : LP 3986

Compressor OEM No : 51 54100 7096

Type / Engine	Eurogasket Part Number	OEM Part Number	Product Picture
TGA 41.430 TGA 41.460 TGA 41.400 Repair Kit	031 5007 800		
TGA 41.430 TGA 41.460 TGA 41.400 Repair Kit	031 5007 890		
TGA 41.430 TGA 41.460 TGA 41.400 Valve Kit	065 600 985		

Disclaimer: OEM numbers are for reference only and do not imply that they are originals parts.



www.eurogasket.com.tr

COMPRESSOR GASKET | To Fit – MAN

Compressor Gasket For : LK 8901

Compressor OEM No : 51 54100 6049

Type / Engine	Eurogasket Part Number	OEM Part Number	Product Picture
TG-A Repair Kit Full	031 5008 900		
TG-A Repair Kit	031 5008 800		
TG-A Gasket Kit	031 5008 890		
TG-A Valve Kit	065 600 958		

Disclaimer: OEM numbers are for reference only and do not imply that they are originals parts.





www.eurogasket.com.tr

COMPRESSOR GASKET | To Fit – MAN

**Compressor Gasket For : LK 8901 – LP 3980
LP 3986 – LP 3997**

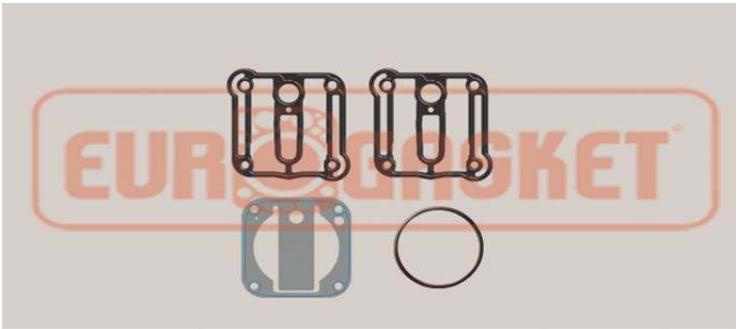
Compressor OEM No : 51 54100 7095

Type / Engine	Eurogasket Part Number	OEM Part Number	Product Picture
TG-A Repair Kit Full	59 56996 4061	51 54114 6049	
TG-A Gasket Kit	031 5009 890		
TG-A Valve Kit	065 600 989		

Disclaimer: OEM numbers are for reference only and do not imply that they are originals parts.



www.eurogasket.com.tr

COMPRESSOR GASKET | To Fit – MAN

Compressor Gasket For : K004489

Compressor OEM No : 51 54100 7116

Type / Engine	Eurogasket Part Number	OEM Part Number	Product Picture
D2066 LF01-04 DF2676 LOH01 TG-A TG-S TG-X Repair Kit	031 5000 800		
D2066 LF01-04 DF2676 LOH01 TG-A TG-S TG-X Gasket Kit	031 5000 890		
D2066 LF01-04 DF2676 LOH01 TG-A TG-S TG-X Valve Kit	065 600 985		

Disclaimer: OEM numbers are for reference only and do not imply that they are originals parts.



www.eurogasket.com.tr

COMPRESSOR GASKET | To Fit – MAN

Compressor OEM No : 51 54114 6065
51 54100 7003

Type / Engine	Eurogasket Part Number	OEM Part Number	Product Picture
G2866UH-UM D2866 LUH23 19.464 Repair Kit	032 5000 800		
G2866UH-UM D2866 LUH23 19.464 Gasket Kit	032 5000 890		
G2866UH-UM D2866 LUH23 19.464 Valve Kit	065 600 984		

Disclaimer: OEM numbers are for reference only and do not imply that they are originals parts.





www.eurogasket.com.tr

COMPRESSOR GASKET | To Fit – MAN

Compressor Gasket For : 4120908012

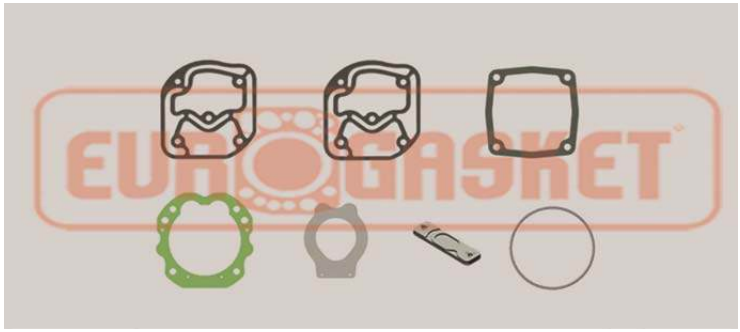
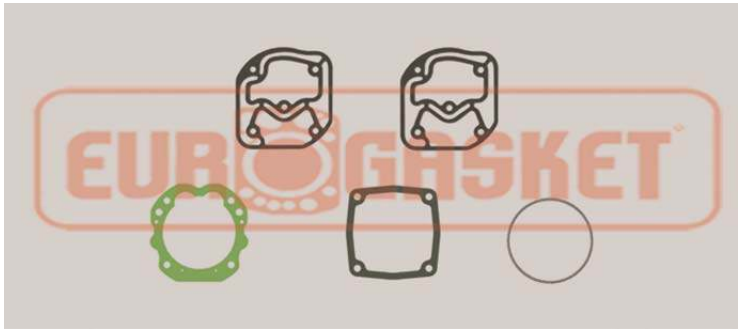
**Compressor OEM No : 51 54100 6007
51 54114 6072**

Type / Engine	Eurogasket Part Number	OEM Part Number	Product Picture
D2866 TUH D2876 LF01 TG-A Repair Kit	033 5000 800		
D2866 TUH D2876 LF01 TG-A Gasket Kit	033 5000 890		
D2866 TUH D2876 LF01 TG-A Gasket Kit	065 600 908		

Disclaimer: OEM numbers are for reference only and do not imply that they are originals parts.







www.eurogasket.com.tr

COMPRESSOR GASKET | To Fit – MAN

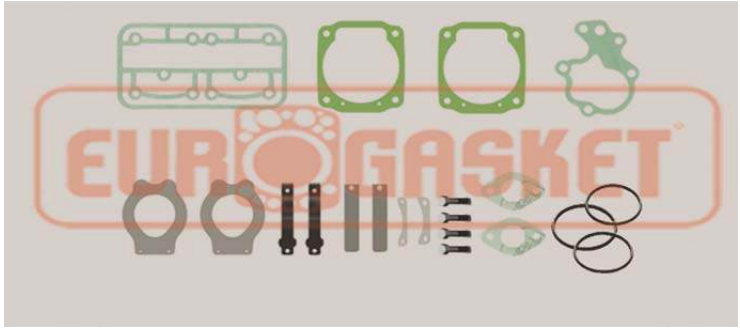
Compressor Gasket For : LK 4908 – II 14779
LK 4911 – II 30897

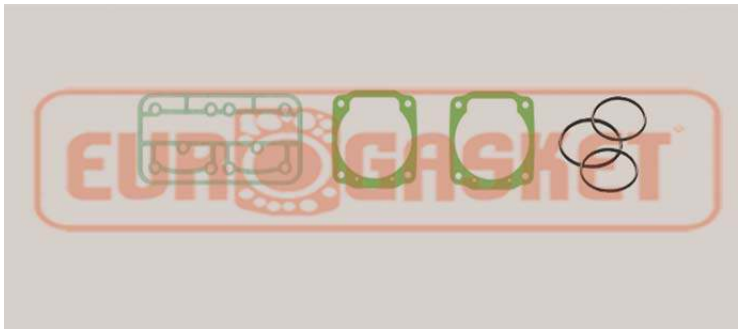
Compressor OEM No : 51 54100 7069

Type / Engine	Eurogasket Part Number	OEM Part Number	Product Picture
NU BUS NM BUS NL BUS Repair Kit Full	034 5098 900		
NU BUS NM BUS NL BUS Repair Kit	034 5098 800		
NU BUS NM BUS NL BUS Gasket Kit	034 5098 890		
NU BUS NM BUS NL BUS Valve Kit	065 600 993		

Disclaimer: OEM numbers are for reference only and do not imply that they are originals parts.



www.eurogasket.com.tr

COMPRESSOR GASKET | To Fit – MAN

Compressor OEM No : 51 54100 6042

Type / Engine	Eurogasket Part Number	OEM Part Number	Product Picture
TG-L Repair Kit	034 5099 800		
TG-L Valve Kit	065 600 901		

Disclaimer: OEM numbers are for reference only and do not imply that they are originals parts.



www.eurogasket.com.tr

COMPRESSOR GASKET | To Fit – MAN

Compressor OEM No : 51 54100 7005
51 54100 6042
412 352 001 2

Type / Engine	Eurogasket Part Number	OEM Part Number	Product Picture
D0836 LF01-06 D0834 LF01 D0834 LOH01 32.270 Repair Kit	034 5090 800		
D0836 LF01-06 D0834 LF01 D0834 LOH01 32.270 Valve Kit	065 600 901		

Disclaimer: OEM numbers are for reference only and do not imply that they are originals parts.



www.eurogasket.com.tr

COMPRESSOR GASKET | To Fit – MAN

Compressor OEM No : 51 54100 6043
51 54101 7240
911 514 000 2

Type / Engine	Eurogasket Part Number	OEM Part Number	Product Picture
D0826 LOH D0826 LFL03 D0826 LF15 32.270 Repair Kit Full	034 5000 900		
D0826 LOH D0826 LFL03 D0826 LF15 32.270 Repair Kit	034 5000 800		
D0826 LOH D0826 LFL03 D0826 LF15 32.270 Repair Kit	034 5000 850		
D0826 LOH D0826 LFL03 D0826 LF15 32.270 Gasket Kit	034 5000 890		
D0826 LOH D0826 LFL03 D0826 LF15 32.270 Valve Kit	065 600 902		

Disclaimer: OEM numbers are for reference only and do not imply that they are originals parts.



www.eurogasket.com.tr

COMPRESSOR GASKET | To Fit – MAN

Compressor OEM No : 51 54100 6043
51 54101 7240
911 514 000 2

Type / Engine	Eurogasket Part Number	OEM Part Number	Product Picture
D0826 LOH D0826 LFL03 D0826 LF15 32.270 Plate Kit	681 999 900		

Disclaimer: OEM numbers are for reference only and do not imply that they are originals parts.



www.eurogasket.com.tr

COMPRESSOR GASKET | To Fit – MAN

Compressor OEM No : 51 54101 7210
411 145 010 0
884 0080 140

Type / Engine	Eurogasket Part Number	OEM Part Number	Product Picture
D0826 TE520 D0826 LE 521 12.153 Repair Kit	035 5000 800		
D0826 TE520 D0826 LE 521 12.153 Valve Kit	065 600 992		

Disclaimer: OEM numbers are for reference only and do not imply that they are originals parts.



www.eurogasket.com.tr

COMPRESSOR GASKET | To Fit – MAN

Compressor OEM No : 51 54101 7204
51 54101 7191

Type / Engine	Eurogasket Part Number	OEM Part Number	Product Picture
D0826 F D2865 LF D0824 LFL01 19.422 Repair Kit	036 5009 800		
D0826 F D2865 LF D0824 LFL01 19.422 Valve Kit	065 600 983		

Disclaimer: OEM numbers are for reference only and do not imply that they are originals parts.



www.eurogasket.com.tr

COMPRESSOR GASKET | To Fit – MAN

**Compressor Gasket For : LK 3805
I 83460**

Compressor OEM No : 51 54101 7150

Type / Engine	Eurogasket Part Number	OEM Part Number	Product Picture
12170 – 12136 - 14170 G90 M90 19.422 Repair Kit	036 5000 800		
12170 – 12136 - 14170 G90 M90 19.422 Valve Kit	065 600 999		

Disclaimer: OEM numbers are for reference only and do not imply that they are originals parts.



www.eurogasket.com.tr

COMPRESSOR GASKET | To Fit – MAN

Compressor OEM No : 51 54000 7064

Type / Engine	Eurogasket Part Number	OEM Part Number	Product Picture
D2866 TUH G2866 UH E2866 DUH01 26.281 Repair Kit	037 5090 800		
D2866 TUH G2866 UH E2866 DUH01 26.281 Valve Kit	065 600 982		

Disclaimer: OEM numbers are for reference only and do not imply that they are originals parts.



www.eurogasket.com.tr

COMPRESSOR GASKET | To Fit – MAN

Compressor Gasket For : 4111429600

Compressor OEM No : 51 54101 7168

Type / Engine	Eurogasket Part Number	OEM Part Number	Product Picture
D0224 MF D0224 DMF D0244 MFO 26.281 Repair Kit	037 5009 800		
D0224 MF D0224 DMF D0244 MFO 26.281 Repair Kit	59 56909 3942	51 54101 7168	
D0224 MF D0224 DMF D0244 MFO 26.281 Gasket Kit	037 5009 850		
D0224 MF D0224 DMF D0244 MFO 26.281 Valve Kit	065 600 998		

Disclaimer: OEM numbers are for reference only and do not imply that they are originals parts.



www.eurogasket.com.tr

COMPRESSOR GASKET | To Fit – MAN

Compressor Gasket For : 4110336532

**Compressor OEM No : 81 54111 0026
81 54112 6007**

Type / Engine	Eurogasket Part Number	OEM Part Number	Product Picture
D0826 F D0824 LFL01 26.281 Repair Kit	037 5000 800		
D0826 F D0824 LFL01 26.281 Valve Kit	065 600 982		

Disclaimer: OEM numbers are for reference only and do not imply that they are originals parts.



www.eurogasket.com.tr

COMPRESSOR GASKET | To Fit – MAN

Compressor Gasket For : LK 3911 – I 85388
LK 3914 – I 90573AT

Compressor OEM No : 51 54101 7192 / 51 54101 7191

Type / Engine	Eurogasket Part Number	OEM Part Number	Product Picture
D0826 F D0826 LOH D0826 FO 26.230 Repair Kit	039 5000 800		
D0826 F D0826 LOH D0826 FO 26.230 Repair Kit	039 5000 809		
D0826 F D0826 LOH D0826 FO 26.230 Gasket Kit	039 5000 850		
D0826 F D0826 LOH D0826 FO 26.230 Valve Kit	065 600 993		

Disclaimer: OEM numbers are for reference only and do not imply that they are originals parts.



www.eurogasket.com.tr

COMPRESSOR GASKET | To Fit – MAN

**Compressor Gasket For : LK 1802 – LK 1814
I 80864 – II 1836**

Compressor OEM No :

Type / Engine	Eurogasket Part Number	OEM Part Number	Product Picture
19.190 Repair Kit	044 5000 800		
19.190 Valve Kit	065 600 993		

Disclaimer: OEM numbers are for reference only and do not imply that they are originals parts.



www.eurogasket.com.tr

COMPRESSOR GASKET | To Fit – MAN

COMPRESSOR GASKET

Type / Engine		Eurogasket Part Number	OEM Part Number	Product Picture
MAN D2566-2866 Compressor Gasket		59 56109 0059	51 54901 0051	
MAN D2566-2866 Compressor Gasket		59 56109 0059	51 54901 0052	



Disclaimer: OEM numbers are for reference only and do not imply that they are originals parts.



www.eurogasket.com.tr

COMPRESSOR GASKET | To Fit – MERCEDES BENZ

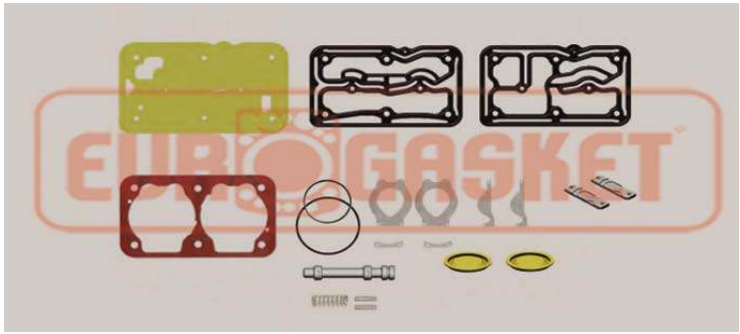
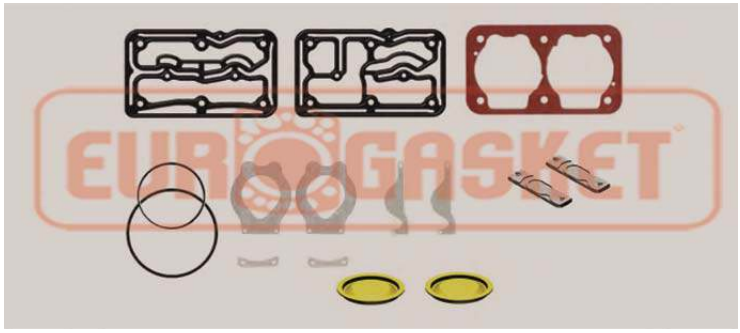
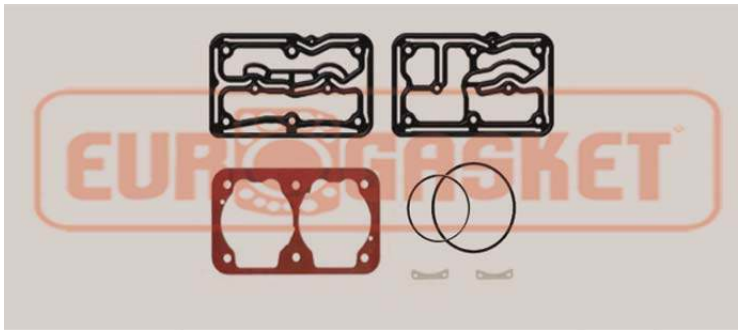
Compressor OEM No : 906 130 0915 / 906 130 2215
412 636 0000

Type / Engine	Eurogasket Part Number	OEM Part Number	Product Picture
CITARO OM 906 Repair Kit Full	014 5009 900		
CITARO OM 906 Repair Kit	014 5009 800		
CITARO OM 906 Gasket Kit	014 5009 890		
CITARO OM 906 Valve Kit	065 600 903		

Disclaimer: OEM numbers are for reference only and do not imply that they are originals parts.



www.eurogasket.com.tr

COMPRESSOR GASKET | To Fit – MERCEDES BENZ

Compressor OEM No : 906 130 1015 / 457 130 2015
911 553 0010

Type / Engine	Eurogasket Part Number	OEM Part Number	Product Picture
AXOR OM 457 EURO III Repair Kit Full	014 5000 900		
AXOR OM 457 EURO III Repair Kit	199 557 1808	911 553 9202	
AXOR OM 457 EURO III Gasket Kit	000 970 4195	000 130 6915	
AXOR OM 457 EURO III Valve Kit	065 600 903		

Disclaimer: OEM numbers are for reference only and do not imply that they are originals parts.



www.eurogasket.com.tr

COMPRESSOR GASKET | To Fit – MERCEDES BENZ

Compressor OEM No : 457 130 3615 / 912 510 1000

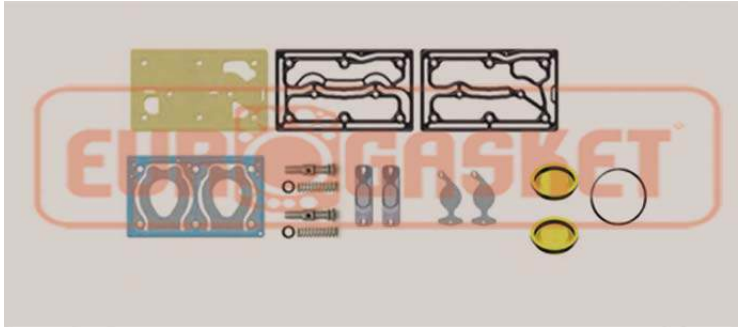
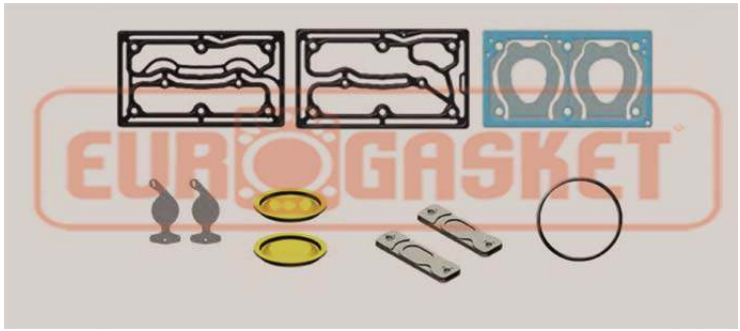
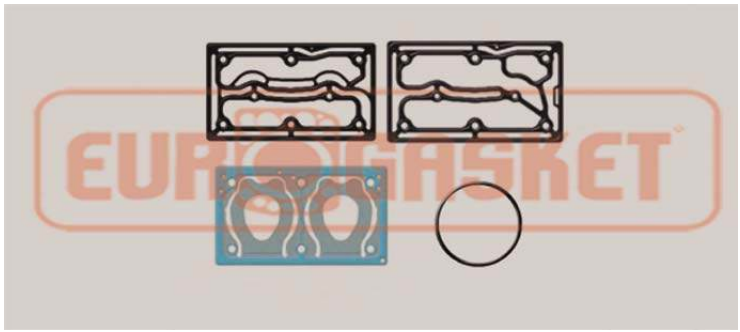
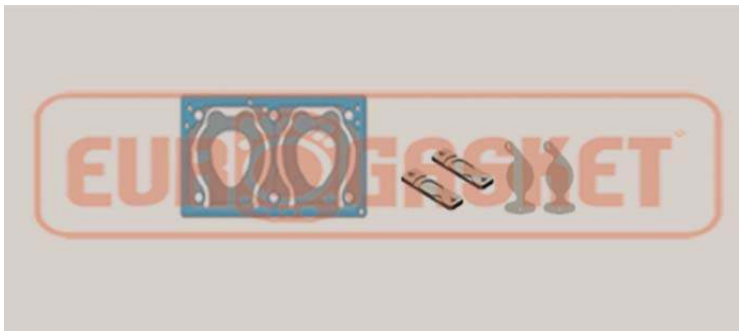
Type / Engine	Eurogasket Part Number	OEM Part Number	Product Picture
AXOR TRAVEGO OM 457 EURO IV Repair Kit Full	016 5075 900		
AXOR TRAVEGO OM 457 EURO IV Repair Kit	016 5075 800		
AXOR TRAVEGO OM 457 EURO IV Gasket Kit	016 5075 890		
AXOR TRAVEGO OM 457 EURO IV Valve Kit	065 600 980		

Disclaimer: OEM numbers are for reference only and do not imply that they are originals parts.



www.eurogasket.com.tr

COMPRESSOR GASKET | To Fit – MERCEDES BENZ

Compressor OEM No : 906 130 1515 / 906 130 3315

Type / Engine	Eurogasket Part Number	OEM Part Number	Product Picture
<p>CITARO OM 906 Repair Kit Full</p>	<p>016 5070 900</p>		
<p>CITARO OM 906 Repair Kit</p>	<p>016 5070 800</p>		
<p>CITARO OM 906 Gasket Kit</p>	<p>016 5070 890</p>		
<p>CITARO OM 906 Valve Kit</p>	<p>065 600 909</p>		

Disclaimer: OEM numbers are for reference only and do not imply that they are originals parts.



www.eurogasket.com.tr

COMPRESSOR GASKET | To Fit – MERCEDES BENZ

Compressor OEM No : 457 130 2715 / 457 130 2615

Type / Engine	Eurogasket Part Number	OEM Part Number	Product Picture
<p>AXOR OM 457LA OM 460LA M 447 HLAG</p> <p>Repair Kit Full</p>	016 5080 900		
<p>AXOR OM 457LA OM 460LA M 447 HLAG</p> <p>Repair Kit</p>	009 970 9095	001 130 1015	
<p>AXOR OM 457LA OM 460LA M 447 HLAG</p> <p>Gasket Kit</p>	016 5080 890		
<p>AXOR OM 457LA OM 460LA M 447 HLAG</p> <p>Valve Kit</p>	065 600 909		

Disclaimer: OEM numbers are for reference only and do not imply that they are originals parts.



www.eurogasket.com.tr

COMPRESSOR GASKET | To Fit – MERCEDES BENZ

Compressor OEM No : 457 130 0815 / 001 130 2615

Type / Engine	Eurogasket Part Number	OEM Part Number	Product Picture
<p>AXOR ATEGO TRAVEGO OM457 LA</p> <p>Repair Kit Full</p>	016 5090 900		
<p>AXOR ATEGO TRAVEGO OM457 LA</p> <p>Repair Kit</p>	016 5090 800		
<p>AXOR ATEGO TRAVEGO OM457 LA</p> <p>Gasket Kit</p>	009 970 8495	001 130 2615	
<p>AXOR ATEGO TRAVEGO OM457 LA</p> <p>Valve Kit</p>	065 600 907		

Disclaimer: OEM numbers are for reference only and do not imply that they are originals parts.



www.eurogasket.com.tr

COMPRESSOR GASKET | To Fit – MERCEDES BENZ

Compressor OEM No : 906 130 0615 / 457 130 0315

Mono Block

Type / Engine	Eurogasket Part Number	OEM Part Number	Product Picture
AXOR Repair Kit Full	016 5008 900		
AXOR Gasket Kit	000 970 5095	000 130 5015	
AXOR Valve Kit	065 600 902		

Disclaimer: OEM numbers are for reference only and do not imply that they are originals parts.



www.eurogasket.com.tr

COMPRESSOR GASKET | To Fit – MERCEDES BENZ

Compressor OEM No : 906 130 2915

Type / Engine	Eurogasket Part Number	OEM Part Number	Product Picture
AXOR ATEGO CITARO Repair Kit	016 5009 800		
AXOR ATEGO CITARO Gasket Kit	016 5009 890		
AXOR ATEGO CITARO Valve Kit	065 600 907		

Disclaimer: OEM numbers are for reference only and do not imply that they are originals parts.



www.eurogasket.com.tr

COMPRESSOR GASKET | To Fit – MERCEDES BENZ

Compressor OEM No : 906 130 2915

Type / Engine	Eurogasket Part Number	OEM Part Number	Product Picture
AXOR ATEGO OM 904-906 Repair Kit	016 5000 800		
AXOR ATEGO OM 904-906 Gasket Kit	016 5000 890		
AXOR ATEGO OM 904-906 Valve Kit	065 600 901		

Disclaimer: OEM numbers are for reference only and do not imply that they are originals parts.



www.eurogasket.com.tr

COMPRESSOR GASKET | To Fit – MERCEDES BENZ

Compressor OEM No : 442 130 3219 / 442 131 0219

Type / Engine	Eurogasket Part Number	OEM Part Number	Product Picture
O 304 O 403 3031 OM 442-443-447 Repair Kit Full	010 5000 900		
O 304 O 403 3031 OM 442-443-447 Repair Kit	010 5000 800		
O 304 O 403 3031 OM 442-443-447 Gasket Kit	010 5000 850		
O 304 O 403 3031 OM 442-443-447 Valve Kit	065 600 990		

Disclaimer: OEM numbers are for reference only and do not imply that they are originals parts.



www.eurogasket.com.tr

COMPRESSOR GASKET | To Fit – MERCEDES BENZ

Compressor OEM No :

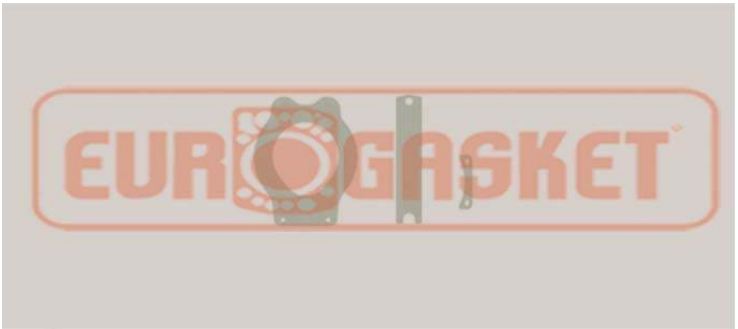
Type / Engine	Eurogasket Part Number	OEM Part Number	Product Picture
EVO BUS OM 401-403-421 Repair Kit	023 5089 800		
EVO BUS OM 401-403-421 Valve Kit	065 600 999		

Disclaimer: OEM numbers are for reference only and do not imply that they are originals parts.



www.eurogasket.com.tr

COMPRESSOR GASKET | To Fit – MERCEDES BENZ

Compressor OEM No : 407 130 0519

Type / Engine	Eurogasket Part Number	OEM Part Number	Product Picture
EVO BUS OM 401-403-421 Repair Kit	023 5080 800		
EVO BUS OM 401-403-421 Valve Kit	065 600 998		

Disclaimer: OEM numbers are for reference only and do not imply that they are originals parts.



www.eurogasket.com.tr

COMPRESSOR GASKET | To Fit – MERCEDES BENZ

Compressor OEM No :

Type / Engine	Eurogasket Part Number	OEM Part Number	Product Picture
OM 401-403-421 Repair Kit Full	023 5099 900		
OM 401-403-421 Repair Kit	023 5099 800		
OM 401-403-421 Gasket Kit	023 5099 850		
OM 401-403-421 Gasket Kit	065 600 998		



Disclaimer: OEM numbers are for reference only and do not imply that they are originals parts.



www.eurogasket.com.tr

COMPRESSOR GASKET | To Fit – MERCEDES BENZ

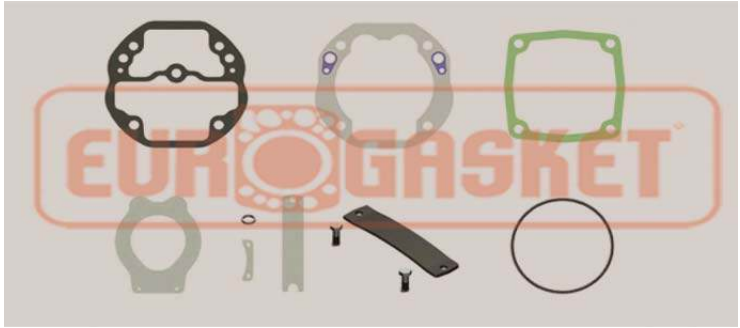
Compressor OEM No : 000 130 2419

Type / Engine	Eurogasket Part Number	OEM Part Number	Product Picture
OM 401-403-421 Repair Kit Full	023 5090 900		
OM 401-403-421 Repair Kit	023 5090 800		
OM 401-403-421 Valve Kit	065 600 999		

Disclaimer: OEM numbers are for reference only and do not imply that they are originals parts.



www.eurogasket.com.tr

COMPRESSOR GASKET | To Fit – MERCEDES BENZ

Compressor OEM No :

Type / Engine	Eurogasket Part Number	OEM Part Number	Product Picture
UNIMOG OM 364 Repair Kit	023 5005 800		
UNIMOG OM 364 Repair Kit	023 5005 809		
UNIMOG OM 364 Valve Kit	065 400 112		

Disclaimer: OEM numbers are for reference only and do not imply that they are originals parts.



www.eurogasket.com.tr

COMPRESSOR GASKET | To Fit – MERCEDES BENZ

Compressor OEM No : 442 130 0220

Type / Engine	Eurogasket Part Number	OEM Part Number	Product Picture
OM 401-403-421 Repair Kit	023 5006 800		
OM 401-403-421 Valve Kit	065 600 995		
OM 401-403-421 Repair Kit	023 5007 800		
OM 401-403-421 Valve Kit	065 600 994		

Disclaimer: OEM numbers are for reference only and do not imply that they are originals parts.



www.eurogasket.com.tr

COMPRESSOR GASKET | To Fit – MERCEDES BENZ

Compressor OEM No : 004 131 0101

Type / Engine	Eurogasket Part Number	OEM Part Number	Product Picture
OM 355 / LA Repair Kit	025 5009 800		
OM 355 / LA Valve Kit	065 600 998		

Disclaimer: OEM numbers are for reference only and do not imply that they are originals parts.



www.eurogasket.com.tr

COMPRESSOR GASKET | To Fit – MERCEDES BENZ

Compressor OEM No : 000 131 4260

Type / Engine	Eurogasket Part Number	OEM Part Number	Product Picture
OM 355 Repair Kit Full	025 5000 900		
OM 355 Repair Kit	025 5000 990		
OM 355 Repair Kit	025 5000 800		
OM 355 Gasket Kit	025 5000 850		
OM 355 Valve Kit	065 600 998		

Disclaimer: OEM numbers are for reference only and do not imply that they are originals parts.



www.eurogasket.com.tr

COMPRESSOR GASKET | To Fit – MERCEDES BENZ

Compressor OEM No : 541 130 2719

Type / Engine	Eurogasket Part Number	OEM Part Number	Product Picture
ACTROS OM 501 LA OM 502 LA Repair Kit Full	026 5008 900		
ACTROS OM 501 LA OM 502 LA Repair Kit	026 5008 800		
ACTROS OM 501 LA OM 502 LA Gasket Kit	026 5008 850		
ACTROS OM 501 LA OM 502 LA Valve Kit	065 600 988		

Disclaimer: OEM numbers are for reference only and do not imply that they are originals parts.



www.eurogasket.com.tr

COMPRESSOR GASKET | To Fit – MERCEDES BENZ

Compressor OEM No :

Type / Engine	Eurogasket Part Number	OEM Part Number	Product Picture
ACTROS OM 501 LA OM 502 LA Repair Kit Full	026 5009 900		
ACTROS OM 501 LA OM 502 LA Repair Kit	026 5009 800		
ACTROS OM 501 LA OM 502 LA Gasket Kit	026 5009 850		
ACTROS OM 501 LA OM 502 LA Valve Kit	065 600 987		

Disclaimer: OEM numbers are for reference only and do not imply that they are originals parts.



www.eurogasket.com.tr

COMPRESSOR GASKET | To Fit – MERCEDES BENZ

Compressor OEM No : 541 131 1219 / 541 131 0919

Type / Engine	Eurogasket Part Number	OEM Part Number	Product Picture
ACTROS OM 501 LA OM 502 LA Repair Kit Full	026 5000 900		
ACTROS OM 501 LA OM 502 LA Repair Kit	026 5000 800		
ACTROS OM 501 LA OM 502 LA Gasket Kit	026 5000 850		
ACTROS OM 501 LA OM 502 LA Valve Kit	065 600 986		

Disclaimer: OEM numbers are for reference only and do not imply that they are originals parts.



www.eurogasket.com.tr

COMPRESSOR GASKET | To Fit – MERCEDES BENZ

Compressor OEM No : 004 131 9401

LK1802 / LK1814 / I80864 / II1836

Type / Engine	Eurogasket Part Number	OEM Part Number	Product Picture
2521 OM 366 LA Repair Kit Full	029 5800 900		
2521 OM 366 LA Repair Kit	029 5800 990		
2521 OM 366 LA Repair Kit	029 5800 800		
2521 OM 366 LA Gasket Kit	029 5800 950		
2521 OM 366 LA Valve Kit	065 600 993		



Disclaimer: OEM numbers are for reference only and do not imply that they are originals parts.



www.eurogasket.com.tr

COMPRESSOR GASKET | To Fit – MERCEDES BENZ

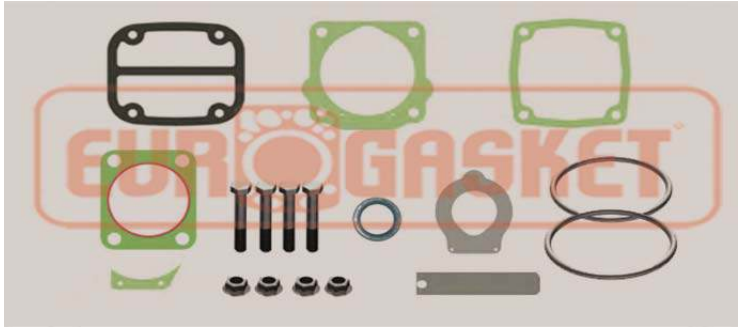
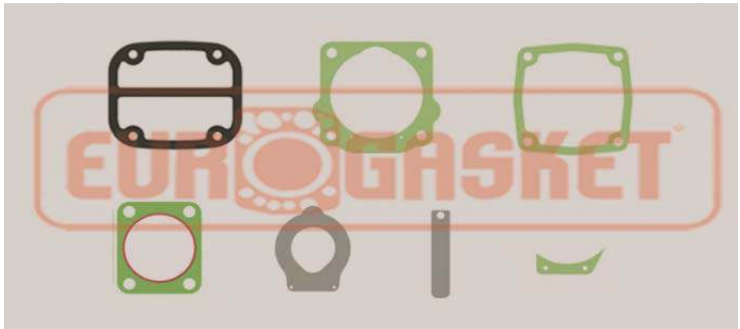
Compressor OEM No : 004 131 0501 / 003 131 4801

Type / Engine	Eurogasket Part Number	OEM Part Number	Product Picture
2517 OM 366 Repair Kit Full	020 5800 900		
2517 OM 366 Repair Kit	020 5800 800		
2517 OM 366 Valve Kit	065 600 991		

Disclaimer: OEM numbers are for reference only and do not imply that they are originals parts.



www.eurogasket.com.tr

To Fit – MERCEDES BENZ

COMPRESSOR GASKET

Type / Engine	Eurogasket Part Number	OEM Part Number	Product Picture
OM 366 Compressor Gasket 0,90 mm	744 979 0920	366 131 0180	
OM 366 Compressor Gasket 0,65 mm	744 979 0920	366 131 0180	
OM 442 Compressor Gasket	668 979 0120	442 131 0980	
OM 442 Compressor Gasket	668 979 0020	442 131 0080	
OM 442 Compressor Gasket	668 979 0320	442 131 0780	

Disclaimer: OEM numbers are for reference only and do not imply that they are originals parts.



www.eurogasket.com.tr

To Fit – MERCEDES BENZ

COMPRESSOR GASKET

Type / Engine	Eurogasket Part Number	OEM Part Number	Product Picture
OM 442 Compressor Gasket	668 979 8620	442 131 2480	
Compressor Valve Disc	000 979 6479	000 131 4631	
Compressor Valve Disc	000 979 7279	000 131 3831	
OM 501-502 Compressor Gasket (Metal)	569 979 0320	541 131 0780	
OM 355 Compressor Gasket Set	6100 48	4900 62	

Disclaimer: OEM numbers are for reference only and do not imply that they are originals parts.



www.eurogasket.com.tr

To Fit – MERCEDES BENZ

COMPRESSOR GASKET

Type / Engine	Eurogasket Part Number	OEM Part Number	Product Picture
Compressor Gasket Set Ø88	6100 875	4900 235	

Disclaimer: OEM numbers are for reference only and do not imply that they are originals parts.



www.eurogasket.com.tr

COMPRESSOR GASKET | To Fit – RENAULT

Compressor OEM No : 20774360

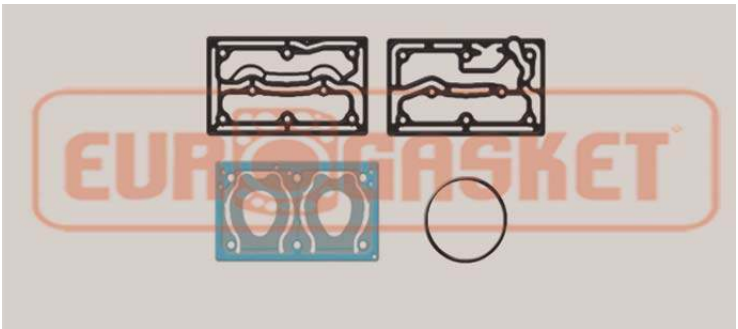
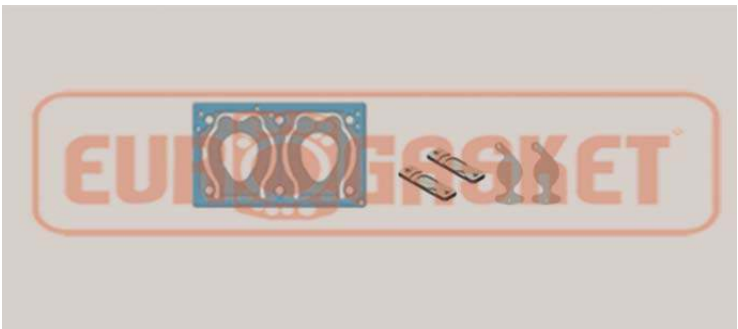
Type / Engine	Eurogasket Part Number	OEM Part Number	Product Picture
PREMIUM 440 Repair Kit Full	987 5006 900		
PREMIUM 440 Repair Kit	987 5006 800		
PREMIUM 440 Gasket Kit	987 5006 890		
PREMIUM 440 Valve Kit	065 600 980		

Disclaimer: OEM numbers are for reference only and do not imply that they are originals parts.



www.eurogasket.com.tr

COMPRESSOR GASKET | To Fit – RENAULT

Compressor OEM No : 5000 694 824
5010 323 738

Type / Engine	Eurogasket Part Number	OEM Part Number	Product Picture
MAGNUM KERAX Repair Kit Full	987 5007 010		
MAGNUM KERAX Repair Kit	987 5007 800		
MAGNUM KERAX Gasket Kit	987 5007 890		
MAGNUM KERAX Valve Kit	065 600 979		



Disclaimer: OEM numbers are for reference only and do not imply that they are originals parts.



www.eurogasket.com.tr

COMPRESSOR GASKET | To Fit – RENAULT

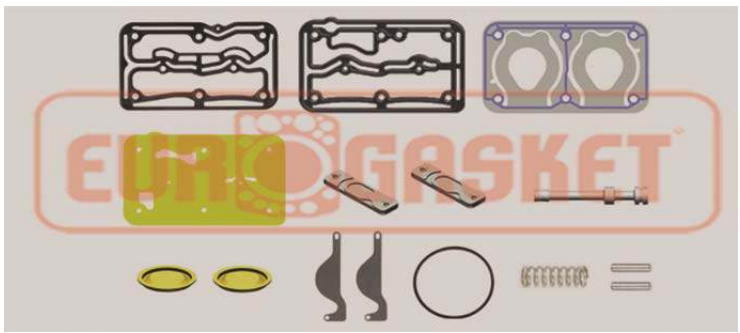
Compressor OEM No : 7420 733 886

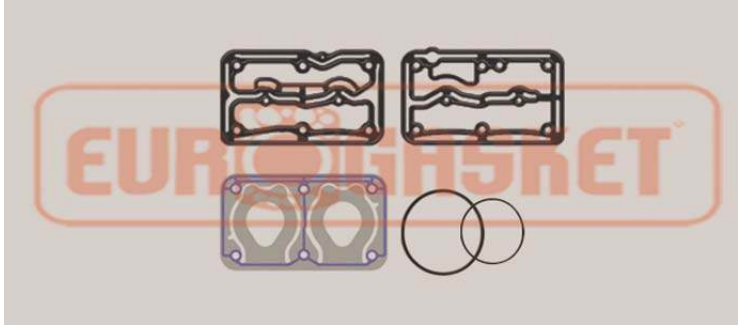
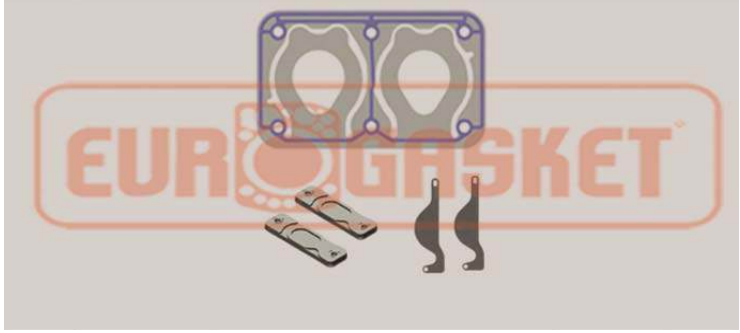
Type / Engine	Eurogasket Part Number	OEM Part Number	Product Picture
MAGNUM DXI Repair Kit Full	987 5008 900		
MAGNUM DXI Repair Kit	987 5008 800		
MAGNUM DXI Gasket Kit	987 5008 890		
MAGNUM DXI Valve Kit	065 600 909		

Disclaimer: OEM numbers are for reference only and do not imply that they are originals parts.



www.eurogasket.com.tr

COMPRESSOR GASKET | To Fit – RENAULT

Compressor OEM No : 5001 859 253

Type / Engine	Eurogasket Part Number	OEM Part Number	Product Picture
<p>PREMIUM KERAX MAGNUM E-TECH</p> <p>Repair Kit Full</p>	987 5009 900		
<p>PREMIUM KERAX MAGNUM E-TECH</p> <p>Repair Kit</p>	987 5009 800		
<p>PREMIUM KERAX MAGNUM E-TECH</p> <p>Gasket Kit</p>	987 5009 890		
<p>PREMIUM KERAX MAGNUM E-TECH</p> <p>Valve Kit</p>	065 600 966		





Disclaimer: OEM numbers are for reference only and do not imply that they are originals parts.

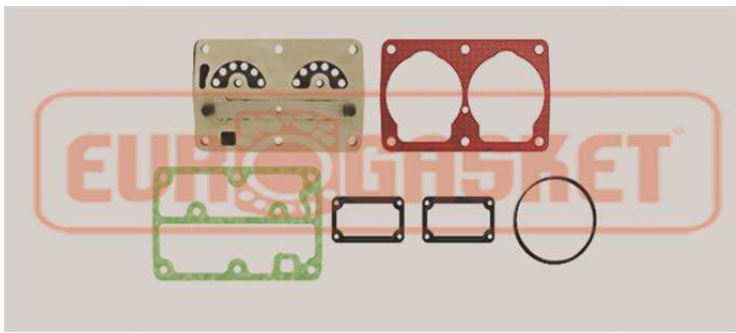

www.eurogasket.com.tr

COMPRESSOR GASKET | To Fit – RENAULT

Compressor OEM No : 5001 867 708

Type / Engine	Eurogasket Part Number	OEM Part Number	Product Picture
PREMIUM KERAX MAGNUM Repair Kit Full	987 5000 010		
PREMIUM KERAX MAGNUM Repair Kit	987 5000 800		
PREMIUM KERAX MAGNUM Gasket Kit	987 5000 890		
PREMIUM KERAX MAGNUM Valve Kit	065 600 979		

Disclaimer: OEM numbers are for reference only and do not imply that they are originals parts.



www.eurogasket.com.tr

COMPRESSOR GASKET | To Fit – SCANIA

Compressor OEM No : 1 537 794
1 745 702

Type / Engine	Eurogasket Part Number	OEM Part Number	Product Picture
N94 4 SERIES BUS Repair Kit Full	909 5904 900		
N94 4 SERIES BUS Repair Kit Full	909 5904 990		
N94 4 SERIES BUS Repair Kit	909 5904 800		
N94 4 SERIES BUS Gasket Kit	909 5904 890		
N94 4 SERIES BUS Valve Kit	065 600 975		

Disclaimer: OEM numbers are for reference only and do not imply that they are originals parts.



www.eurogasket.com.tr

COMPRESSOR GASKET | To Fit – SCANIA

Compressor Gasket For : LP 4920 – LP 4970

Compressor OEM No : 1 396 282

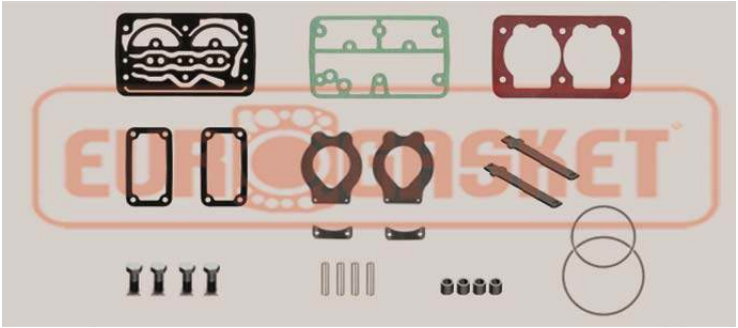
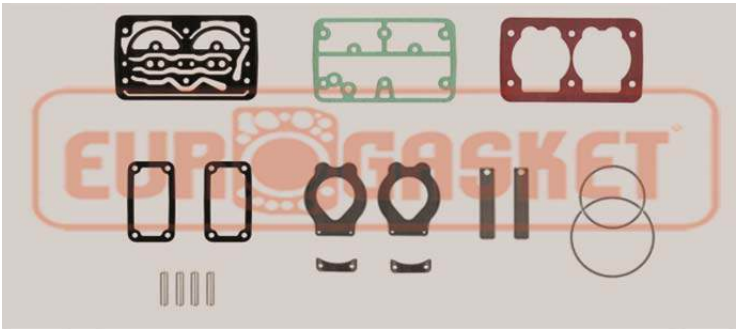
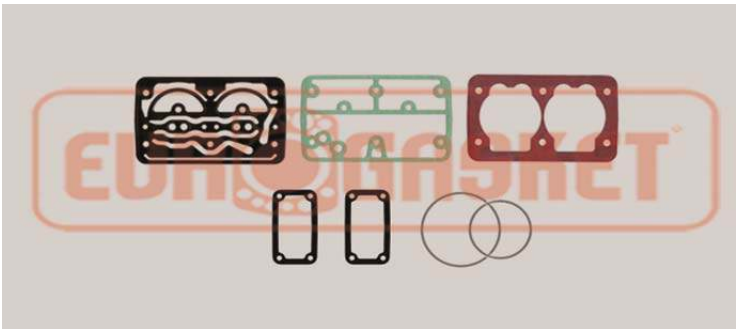
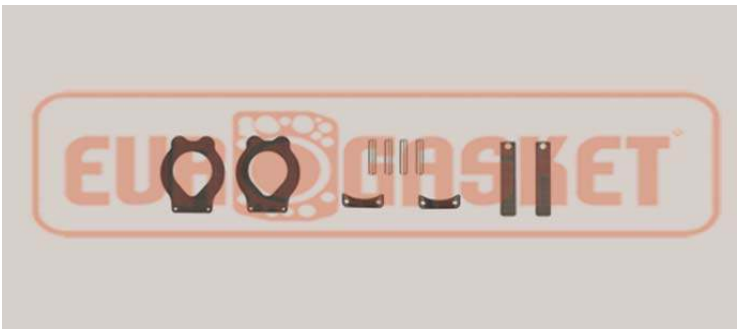
Type / Engine	Eurogasket Part Number	OEM Part Number	Product Picture
Repair Kit Full	909 5905 900		
Repair Kit	909 5905 800		
Gasket Kit	909 5905 890		
Valve Kit	065 600 997		

Disclaimer: OEM numbers are for reference only and do not imply that they are originals parts.



www.eurogasket.com.tr

COMPRESSOR GASKET | To Fit – SCANIA

Compressor Gasket For : LP 4957 – LP 4963

Compressor OEM No : 1 796 663 / 1 379 094 / 1 513 115

Type / Engine	Eurogasket Part Number	OEM Part Number	Product Picture
<p>4 SERIES P,R,T TRUCK Repair Kit Full</p>	<p>909 5906 900</p>		
<p>4 SERIES P,R,T TRUCK Repair Kit</p>	<p>909 5906 800</p>		
<p>4 SERIES P,R,T TRUCK Gasket Kit</p>	<p>909 5906 890</p>		
<p>4 SERIES P,R,T TRUCK Gasket Kit</p>	<p>065 600 906</p>		

Disclaimer: OEM numbers are for reference only and do not imply that they are originals parts.



www.eurogasket.com.tr

COMPRESSOR GASKET | To Fit – SCANIA

Compressor Gasket For : LP 4825 – LP 4829

Compressor OEM No : 3 090 378

Type / Engine	Eurogasket Part Number	OEM Part Number	Product Picture
Repair Kit Full	909 5907 900		
Repair Kit	909 5907 800		
Gasket Kit	909 5907 890		
Valve Kit	065 400 970		

Disclaimer: OEM numbers are for reference only and do not imply that they are originals parts.



www.eurogasket.com.tr

COMPRESSOR GASKET | To Fit – SCANIA

**Compressor Gasket For : LP 4814 – LP 4815
LP 4844**

Compressor OEM No : 1 303 226 / 571183 / 1 381 951

Type / Engine	Eurogasket Part Number	OEM Part Number	Product Picture
3 SERIES 4 SERIES Repair Kit Full	909 5908 900		
3 SERIES 4 SERIES Repair Kit	909 5908 800		
3 SERIES 4 SERIES Gasket Kit	909 5908 890		
3 SERIES 4 SERIES Valve Kit	065 600 979		

Disclaimer: OEM numbers are for reference only and do not imply that they are originals parts.



www.eurogasket.com.tr

COMPRESSOR GASKET | To Fit – SCANIA

Compressor Gasket For : TUFLO 700

Compressor OEM No : 1 348 920 / 1 348 919 / 394441

Type / Engine	Eurogasket Part Number	OEM Part Number	Product Picture
3 SERIES Repair Kit Full	909 5909 900		
3 SERIES Repair Kit Full	909 5909 990		
3 SERIES Repair Kit Full	909 5909 980		
3 SERIES Repair Kit	909 5909 800		
3 SERIES Gasket Kit	909 5909 890		

Disclaimer: OEM numbers are for reference only and do not imply that they are originals parts.



www.eurogasket.com.tr

COMPRESSOR GASKET | To Fit – SCANIA

Compressor Gasket For : TUFLO 700

Compressor OEM No : 1 348 920 / 1 348 919 / 394441

Type / Engine	Eurogasket Part Number	OEM Part Number	Product Picture
3 SERIES Gasket Kit	909 5909 895		

Disclaimer: OEM numbers are for reference only and do not imply that they are originals parts.



www.eurogasket.com.tr

COMPRESSOR GASKET | To Fit – VOLVO

Type / Engine	Eurogasket Part Number	Compressor OEM Number	Product Picture
FL 7 FL 10 FL 12 Repair Kit	908 5000 900	272813	
FL 7 FL 10 FL 12 Repair Kit Full	908 5008 010	1080437 1612335	
FL 16 FL 10 FL 7 B7 Repair Kit	908 5005 900	1613632 5003217	
FM 9 Repair Kit	908 5001 900	20451727 20382348	
FL 12 Repair Kit	908 5090 800	20423341	

Disclaimer: OEM numbers are for reference only and do not imply that they are originals parts.



www.eurogasket.com.tr

COMPRESSOR GASKET | To Fit – VOLVO

Type / Engine	Eurogasket Part Number	Compressor OEM Number	Product Picture
FL 12 Repair Kit	908 5099 010	1699822 20429337	
FH 12 FM 12 Repair Kit	908 5098 980	20569224 20701803	
FL 6 Repair Kit	908 5097 900	4897300 8113829	
FL 6 Repair Kit	908 5096 800	3181133 20568594	
FM 9 FM 12 Repair Kit	908 5095 900	20478166 20733972	

Disclaimer: OEM numbers are for reference only and do not imply that they are originals parts.



www.eurogasket.com.tr

COMPRESSOR GASKET | To Fit – VOLVO

Type / Engine	Eurogasket Part Number	Compressor OEM Number	Product Picture
FH 12 FH 16 Repair Kit	908 5094 900	20845313 20773343	
B12 M B12 B Repair Kit	908 5093 900	20770303 9125120060	
FM 12 NH 12 Repair Kit	908 5092 900	20701801 20382347 4127040010	
FH 16 Repair Kit	908 5080 900	20569251	
B 7 Repair Kit	908 5089 990		

Disclaimer: OEM numbers are for reference only and do not imply that they are originals parts.



www.eurogasket.com.tr

COMPRESSOR GASKET | To Fit – VOLVO

Type / Engine	Eurogasket Part Number	Compressor OEM Number	Product Picture
F 10 F 12 NL 10 NL 12 Repair Kit	908 5806 900	3090378 8150407	
B 10 B 12 FH 12 FH 16 Repair Kit	908 5804 900	162859 8112584	
F 10 F 12 FL 7 Repair Kit	908 5803 900	85104629 8112426	
FM 7 FM 12 B 10 Repair Kit	908 5802 900	3095843 8113405	

Disclaimer: OEM numbers are for reference only and do not imply that they are originals parts.



www.eurogasket.com.tr

INDEX PAGE

To Fit
DAF

OEM Part Number	Eurogasket Part Number	Description	Page Number
0 098 519	0 012 591	85-95 OIL PAN GASKET	8
0 227 103	0 883 907	1160-2800 EXHAUST MANIFOLD GASKET	11
0 240 564	0 860 546	825 VALVE COVER GASKET	9
0 241 103	0 869 907	1160-2300-2800 VALVE COVER GASKET	9
0 241 144	0 869 966	1160-2300-2800 VALVE COVER GASKET (MVQ)	9
0 241 297	0 869 813	2600-2800-3300-3600 INTAKE MANIFOLD GASKET	10
0 241 297	0 869 813	2300-2800-3300-3600 EXHAUST MANIFOLD GASKET	11
0 241 374	0 869 736	1160 INTAKE MANIFOLD GASKET	10
0 241 374	0 869 736	2300-2800-3300-3600 EXHAUST MANIFOLD GASKET	11
0 242 216	0 868 894	F1600 EXHAUST MANIFOLD GASKET	11
0 269 548	0 841 562	85-95 EXHAUST MANIFOLD GASKET	11
0 390 655	0 710 455	1160-2300-2800 CYLINDER HEAD GASKET	6
0 683 191	0 427 919	CF85-95 / XE250-280-315-355-390 / 95XF CONVERSION SET	5
0 753 623	0 357 487	1160-2300-2800 OIL PAN GASKET	8
0 94196	0 16914	1160-2300-2800 / WS95-95XF TURBO GASKET	12
0094 701	0016 309	825 CYLINDER HEAD GASKET (WITHOUT RING)	6
0682 667	0428 443	615 HEAD SET GASKET	2
0682 669	0428 441	825 HEAD SET GASKET	2
0682 677	0 428 433	1160-2300-2800 HEAD SET GASKET	2
0682 680	0428 420	85-95 HEAD SET GASKET	2
0682 885	04282 25	620 HEAD SET GASKET	2
0682667+761513+682685	0428443+349597+428425	615 FULL SET GASKET	1
0683 532	0427 578	85XF-95XF-XE250-280-315-355-390 HEAD SET GASKET	3
1 243 371	9 867 739	DD575 / F900-1100-1500-1600-1800 CYLINDER HEAD GASKET	7
1 283 129	9 827 981	620 CYLINDER HEAD GASKET	6
1 300 061	9 700 049	95XF VALVE COVER GASKET	9
1 302 930	9 708 170	1160-2300-2800 / WS95-95XF TURBO GASKET	12
1 320 372	9 780 738	95-95XF CYLINDER HEAD GASKET	6
1 336 089	9 774 021	85-95 INTAKE MANIFOLD GASKET	10
1 336 090	9 774 010	85-95 INTAKE MANIFOLD GASKET	10
1 339 668	9 771 442	825 CYLINDER HEAD GASKET (WITH RING)	6
1 341 529	9 769 581	95XF VALVE COVER GASKET	9
1 361 567	9 769 543	95XF VALVE COVER GASKET (WITH SILICONED)	9
1 361 567	9 749 543	95XF VALVE COVER GASKET	9
1 676 984	9 434 126	95XF EXHAUST MANIFOLD GASKET	11
118 730	992 370	DK1160-DKA1160-F2400-2600-2800 CONVERSION SET	5
118730+0682677+0390655	992370+0428433+0710455	1160-2300-2800 FULL SET GASKET	1
145 8701	965 2309	95XF-530 OIL PAN GASKET	8
233 473	877 637	F1600 TURBO GASKET	12
260 304	840 706	DA475-DD475-DD575-F900-1100-1300-1400-1600 HEAD SET GASKET	3
376 571	734 539	825/ F1800-2000-2100-2200-2300-2500-2700 OIL PAN GASKET	8
681 671	429 439	F95-WS225-242-259-268-282-WS1160 CONVERSION SET	5
682 673	428 437	DHS825-DHT825-F2100-2300-2500 HEAD SET GASKET	3
682 682	428 428	RF865-RJ865-F75-CF85 HEAD SET GASKET	3
682 685	428 425	DA475-DD475-DD575 / F900-1100-1300-1400-1600 CONVERSION SET	5
683 103	427 907	DH825-DHB825 CONVERSION SET	5
683 337	427 773	95XF HEAD SET GASKET	3
683103+1339668+0682669	427907+9771442+0428441	825 FULL SET GASKET	1
754 143	356 967	475-515-615-F900-1100-1300-1500-1600-1800 OIL PAN GASKET	8
761 513	349 597	615 CYLINDER HEAD GASKET	7
	428 420	95WS-F80-F95 FULL SET GASKET	1
	0427 773	85CF-95XF FULL SET GASKET	1
	0840 706	DA475-DD475-DD575-F900-1100-1300-1400-1600 FULL SET GASKET	4
	0428 428	RF865-RS865-F75-CF85 FULL SET GASKET	4



www.eurogasket.com.tr

INDEX PAGE

To Fit
DEUTZ

OEM Part Number	Eurogasket Part Number	Description	Page Number
0111 8700	0999 2300	TCD 2013 OIL RADIATOR RUBBER	50
0116 0592	0994 0518	FL 912 / 913 INJECTOR RUBBER 1 HOLE	54
0210 1802	0890 9208	FL 912 / 913 INJECTOR RUBBER 8 HOLE	54
0213 1577	0897 9533	F8L 413 / 413F/V OIL PAN GASKET	37
0213 1579	0897 9531	F12L 413 / F / V OIL PAN GASKET	37
0213 6719	0897 4391	F4L 912 OIL PAN GASKET 4 PCS. (THICK)	38
0213 6719	0897 4391	F4L 912 OIL PAN GASKET (THICK)	38
0213 6720	0897 4380	F6L 912/913 OIL PAN GASKET (THICK)	39
0213 6720	0897 4380	F6L 912913 OIL PAN GASKET 4 PCS. (THICK)	39
0213 7256	0897 3854	FL 912/913 SHIM 0,20mm	52
0215 8472	0895 2638	F6-8M 716 1,50mm	52
0223 0704	0887 0306	FL 912/913 INTAKE MANIFOLD GASKET	44
0223 2840	0887 8260	FL 912/913/914 PUSHROD SEAL	54
0223 2963	0887 8147	FL 912/913 SHIM 0,50mm (NOTCH)	52
0223 9331	0887 1779	FL 912/913 SHIM 1,00mm	52
0224 0933	0886 0177	F5L 912 OIL PAN GASKET	39
0240 2812	0860 8298	FL 413 VALVE COVER GASKET	41
0240 3119	0860 7991	F6L 413 / 413F / 413 V OIL PAN GASKET	37
0240 3140	0860 7960	FL 413 SHIM 0,10mm	52
0240 3141	0860 7969	FL 413 SHIM 0,20mm	52
0240 3142	0860 7968	FL 413 SHIM 0,30mm	52
0241 9006	0869 1004	FL 413 SHIM 0,50mm	52
0247 3509	0863 7501	F4L 413R FULL SET GASKET	16
0247 8209	0863 2801	F4L 413FR FULL SET GASKET	17
0291 0164	0819 0946	F6L 614 HEAD SET GASKET	28
0291 0178	0819 0932	FL 716 HEAD SET GASKET	28
0291 1516	0819 9594	FL 413V HEAD SET GASKET	27
0291 1516	0819 9594	FL 413R HEAD SET GASKET	27
0291 1521	0819 9589	F6L 413V FULL SET GASKET	15
0291 1523	0819 9587	F5L 413R FULL SET GASKET	16
0291 1524	0819 9586	F6L 413R FULL SET GASKET	17
0291 1527	0819 9583	F10L 413V FULL SET GASKET	15
0291 1528	0819 9582	F12L 413V FULL SET GASKET	15
0291 1550	0819 9550	FL 413FR HEAD SET GASKET	27
0291 1558	0819 9552	FL 816 HEAD SET GASKET	28
0291 1586	0819 9524	FL 714 HEAD SET GASKET	28
0291 1588	0819 9522	F6-8L 714 FULL SET GASKET	19
0292 8729	0818 2381	FL 1011 CONVERSION SET (ALL TYPE)	26
0292 8809	0818 2201	F8L 413F/513 FULL SET GASKET	16
0292 8810	0818 2290	FL 413F / 513 HEAD SET GASKET	27
0292 8811	0818 2299	F6L 413F FULL SET GASKET	15
0292 8812	0818 2298	BF8L 513 FULL SET GASKET	18
0292 8813	0818 2297	F10L 413F/513 FULL SET GASKET	16
0292 8815	0818 2295	BF12L 413F FULL SET GASKET	17
0292 8816	0818 2294	BF12L 513 FULL SET GASKET	18
0292 8820	0818 2280	F10L 413FW FULL SET GASKET	16
0292 8822	0818 2288	F5L 413FR FULL SET GASKET	17
0292 8823	0818 2287	F6L 413FR FULL SET GASKET	17
0292 8826	0818 2284	BF6L 513T FULL SET GASKET	18
0292 8832	0818 2278	F8L 413V FULL SET GASKET	15
0292 8843	0818 2267	F2L 1011 HEAD SET GASKET	29
0292 8843+0292 8729	0818 2267+0818 2381	F2L/BF2L 1011 FULL SET GASKET	22
0292 8844	0818 2266	F3L 1011 HEAD SET GASKET	30
0292 8844+0292 8729	0818 2266+0818 2381	F3L/BF3L 1011 FULL SET GASKET	22
0292 8845	0818 2265	F4L 1011 HEAD SET GASKET	30
0292 8845+02928729	0818 2265+0818 2381	F4L/BF4L 1011 FULL SET GASKET	23



www.eurogasket.com.tr

INDEX PAGE

To Fit
DEUTZ

OEM Part Number	Eurogasket Part Number	Description	Page Number
0292 8852+0292 8729	0818 225+0818 2381	F2L/BF2L 1011F FULL SET GASKET	22
0292 8879	0818 2231	BF4L 1011 HEAD SET GASKET	30
0292 8994	0818 2116	FL 912/913 HEAD SET GASKET	29
0292 9047	0818 1063	F2L 511 FULL SET GASKET	18
0292 9050	0818 1050	FL 511 HEAD SET GASKET	27
0292 9305	0818 1705	FL 514 / 614 EXHAUST MANIFOLD GASKET	45
0292 9638	0818 1472	BF4L 913 FULL SET GASKET	21
0292 9649	0818 1461	F4L 912 FULL SET GASKET	20
0292 9650	0818 1450	F6L 912 FULL SET GASKET	20
0292 9651	0818 1459	F5L 912 FULL SET GASKET	20
0292 9652	0818 1458	F2L 912 FULL SET GASKET	20
0292 9657	0818 1454	F3L 912 FULL SET GASKET	20
0292 9657	0818 1453	BF6L 913 FULL SET GASKET	21
0292 9852	0818 1258	F2L 1011F HEAD SET GASKET	29
0292 9853	0818 1257	F3L 1011F HEAD SET GASKET	29
0292 9853+0292 9856	0818 1257+0818 1254	F3L/BF3M 1011F FULL SET GASKET	22
0292 9854	0818 2267	F4L 1011F HEAD SET GASKET	31
0292 9854+0292 9856	0818 1256+0818 1254	F4L/BF4L 1011F FULL SET GASKET	23
0292 9855	0818 1255	BF4L 1011F HEAD SET GASKET	31
0293 1117	0817 9993	BF3M 1011 F HEAD SET GASKET	30
0293 1118	0817 9992	FL 1011F CONVERSION SET (ALL TYPE)	26
0293 1141	0817 9969	BF4M 1011F HEAD SET GASKET	30
0293 1276	0817 9834	BF4M 1012 FULL SET GASKET	23
0293 1277	0817 9833	BF6M 1012 FULL SET GASKET	23
0293 1278	0817 9832	BF4M 1013 FULL SET GASKET	23
0293 1279	0817 9831	BF6M 1013 FULL SET GASKET	24
0293 1426	0817 9684	FL 914 HEAD SET GASKET	29
0293 1431	0817 9679	BF4M 2012 FULL SET GASKET	25
0293 1432	0817 9678	BF6M 2012 FULL SET GASKET	25
0293 1434	0817 9676	F3M 2011 FULL SET GASKET	24
0293 1435	0817 9675	F4M 2011 FULL SET GASKET	24
0293 1478	0817 9632	BF6M 1015 FULL SET GASKET	24
0293 1479	0817 9631	BF8M 1015 FULL SET GASKET	24
0293 1511	0817 9599	F3L 914 FULL SET GASKET	21
0293 1512	0817 9598	F4L 914 FULL SET GASKET	21
0293 1513	0817 9597	F5L 914 FULL SET GASKET	21
0293 1514	0817 9596	F6L 914 FULL SET GASKET	22
0293 1662	0817 9448	TC6L 2012 2V FULL SET GASKET	25
0293 1663	0817 9447	TC6L 2013 2V FULL SET GASKET	26
0293 1762	0817 9348	TC4L 2012 2V FULL SET GASKET	25
0293 1763	0817 9347	TC4L 2013 2V FULL SET GASKET	25
0330 5749	0770 5361	F2L 514 FULL SET GASKET	18
0330 5749	0770 5361	FL 514 HEAD SET GASKET	28
0336 1809	0774 9201	FL 912 / 913 INJECTOR RUBBER 2 HOLE	54
0336 2170	0774 8930	FL 413 EXHAUST MANIFOLD GASKET	45
0336 2573	0774 8537	F3L 912 /913 OIL PAN GASKET	38
0336 2573	0774 8537	F3L 912 /913 OIL PAN GASKET (THIN)	38
0336 2574	0774 8536	F4L 912 OIL PAN GASKET (THIN)	38
0336 2581	0774 8529	F6L 912/913 OIL PAN GASKET (THIN)	39
0336 5761	0774 5349	FL 514/614 VALVE COVER GASKET	41
0337 1689	0773 9421	FL 912 EXHAUST MANIFOLD GASKET	45
0337 1692	0773 9418	FL 511/912/913 VALVE COVER GASKET	41
0337 1692	0773 9418	FL 511/912/913 VALVE COVER GASKET (REINZ TYPE)	41
0337 3414	0773 7696	FL 716 / 816 SEALIN RING	54
0337 3415	0773 7695	FL 716 / 816 SEALIN RING	54
0337 3421	0773 7689	F6-8M 716 1,00mm	52



www.eurogasket.com.tr

INDEX PAGE

To Fit
DEUTZ

OEM Part Number	Eurogasket Part Number	Description	Page Number
0347 0138	0763 0972	F6M 716 VALVE COVER GASKET	41
0400 0649	0600 0461	GASKET	50
0405 4665	0605 6445	GASKET	49
0407 0445	0603 0665	AXLE GASKET	49
0407 0578	0603 0532	GASKET	50
0409 2159	0601 8951	D-628 TURBO GASKET	46
0409 3410	0601 7690	D-628 EXHAUST MANIFOLD GASKET	46
0409 3794	0601 7316	D-628 EXHAUST MANIFOLD GASKET	46
0414 1486	0696 9624	FL 413 / 413F / 513 INTAKE MANIFOLD GASKET	44
0414 7308	0696 3702	FL 413 F/FR/513 VALVE COVER GASKET	41
0414 9732	0696 1378	FL 413 SHIM 0,70mm	52
0414 9733	0696 1377	FL 413 SHIM 1,00mm	52
0415 0264	0695 0846	FL 912/913 SHIM 0,80mm	52
0415 3358	0695 7752	FL 912/913 SHIM 0,30mm	52
0415 3728	0695 7382	FL 1011 / 2011 VALVE STEM SEAL	54
0415 7246	0695 3864	BF4M 1013 / BF6M 1012 TURBO GASKET	47
0415 7260	0695 3840	FL 913 TURBO GASKET	47
0415 7360	0395 3740	FL 912/913/914 GASKET DONUT	45
0415 7466	0695 3644	FL 912/913 SHIM 1,40mm	52
0415 7467	0695 3643	FL 912/913 SHIM 1,50mm	52
0415 7470	0695 3630	FL 912/913 SHIM 1,60mm	52
0415 7654	0695 3456	FL 912/913 SHIM 1,10mm	52
0415 7655	0695 3455	FL 912/913 SHIM 1,15mm	52
0415 7657	0695 3453	FL 912/913 SHIM 1,25mm	52
0415 7658	0695 3452	FL 912/913 SHIM 1,30mm	52
0415 7668	0695 3442	FL 912/913 SHIM 1,20mm	52
0417 0569	0693 0541	F4L 1011 CYLINDER HEAD GASKET - 1 NOTCH	32
0417 0570	0693 0530	F4L 1011 CYLINDER HEAD GASKET - 2 NOTCH	32
0417 0571	0693 0539	F4L 1011 CYLINDER HEAD GASKET - 3 NOTCH	32
0417 0572	0693 0538	F3L 1011 CYLINDER HEAD GASKET - 1 NOTCH	32
0417 0573	0693 0537	F3L 1011 CYLINDER HEAD GASKET - 2 NOTCH	32
0417 0574	0693 0536	F3L 1011 CYLINDER HEAD GASKET - 3 NOTCH	32
0417 0575	0693 0535	F2L 1011 CYLINDER HEAD GASKET - 1 NOTCH	32
0417 0576	0693 0534	F2L 1011 CYLINDER HEAD GASKET - 2 NOTCH	32
0417 0577	0693 0533	F2L 1011 CYLINDER HEAD GASKET - 3 NOTCH	32
0417 2446	0693 8664	F/BF4L 1011F - BF4M 1012	47
0417 3857	0693 7253	F2L 1011 VALVE COVER GASKET	41
0417 3858	0693 7252	F3L 1011 VALVE COVER GASKET	41
0417 3859	0693 7251	F4L 1011F VALVE COVER GASKET	42
0417 3861	0693 7249	FL 1011 INTAKE MANIFOLD GASKET	44
0417 3862	0693 7248	FL 1011/2011 EXHAUST MANIFOLD GASKET	45
0417 8854	0693 2256	F3L 1011F CYLINDER HEAD GASKET - 1 NOTCH	32
0417 8855	0693 2255	F3L 1011F CYLINDER HEAD GASKET - 2 NOTCH	32
0417 8856	0693 2254	F3L 1011F CYLINDER HEAD GASKET - 3 NOTCH	32
0417 8861	0693 2249	F2L 1011F CYLINDER HEAD GASKET - 1 NOTCH	32
0417 8862	0693 2248	F2L 1011F CYLINDER HEAD GASKET - 2 NOTCH	32
0417 8863	0693 2247	F2L 1011F CYLINDER HEAD GASKET - 3 NOTCH	32
0417 8867	0693 2243	F4L 1011F CYLINDER HEAD GASKET - 1 NOTCH	33
0417 8868	0693 2242	F4L 1011F CYLINDER HEAD GASKET - 2 NOTCH	33
0417 8869	0693 2241	F4L 1011F CYLINDER HEAD GASKET - 3 NOTCH	33
0417 9845	0693 1265	F2L 1011F /2011 VALVE COVER GASKET	41
0417 9846	0693 1264	F3L 1011F / 2011 VALVE COVER GASKET	41
0417 9847	0693 1263	B/F4L 1011 - F4L/M 2011 VALVE COVER GASKET	42
0418 2519	0692 8591	FL 913 TURBO GASKET	47
0418 2520	0692 8580	FL 913 TURBO GASKET	47
0418 2521	0692 8589	FL 913 TURBO GASKET	47



www.eurogasket.com.tr

INDEX PAGE

To Fit
DEUTZ

OEM Part Number	Eurogasket Part Number	Description	Page Number
0418 3249	0692 7861	FL 413F / 513 SHIM 0,50mm	52
0418 3250	0692 7850	FL 413F / 513 SHIM 0,70mm	52
0418 3251	0692 7859	FL 413F / 513 SHIM 1,00mm	52
0418 4091	0692 6019	FL 413F/FR/513 GASKET	43
0418 4903	0692 6107	FL 413 / 513 EXHAUST MANIFOLD GASKET (3 HOLE)	45
0418 8209	0692 2801	F4L 413R / FR OIL PAN GASKET	37
0418 8210	0692 2890	F6L 413R / FR / 513 OIL PAN GASKET	37
0419 8387	0691 2723	BFM 1012 INTAKE MANIFOLD GASKET	44
0419 8796	0691 2314	BF4M 1012 VALVE COVER GASKET	42
0419 8968	0691 2142	BFM 1013 WATER PUMP GASKET	48
0419 8969	0691 2141	BF6M 1012 VALVE COVER GASKET	42
0420 0095	0680 0015	BFM 1013 INTAKE MANIFOLD GASKET	44
0420 1559	0680 9551	BF6M 1013 CYLINDER HEAD GASKET - 1 NOTCH	33
0420 1560	0680 9540	BF6M 1013 CYLINDER HEAD GASKET - 2 NOTCH	33
0420 1561	0680 9549	BF6M 1013 CYLINDER HEAD GASKET - 3 NOTCH	33
0420 1562	0680 9548	BF4M 1013 CYLINDER HEAD GASKET - 1 NOTCH	33
0420 1563	0680 9547	BF4M 1013 CYLINDER HEAD GASKET - 2 NOTCH	33
0420 1564	0680 9546	BF4M 1013 CYLINDER HEAD GASKET - 3 NOTCH	33
0420 2180	0680 8920	BFM 1012/1013 GASKET	48
0420 2974	0680 8136	BFM 1012 / 2012 GASKET	48
0420 2975	0680 8135	BFM 1012/2012 WATER PUMP GASKET	48
0420 4452	0680 6658	BF4M 1012/2012 OIL PAN GASKET	39
0420 4458	0680 6652	BF4M 1013 / 2013 OIL PAN GASKET	40
0420 4459	0680 6651	BF6M 1013 / 2013 OIL PAN GASKET	40
0420 5894	0680 5216	BF6M 1013 VALVE COVER GASKET	42
0420 5895	0680 5215	BF4M 1013 VALVE COVER GASKET	42
0420 9196	0680 1914	BF4M 1012 TURBO GASKET	47
0420 9203	0680 1807	BF6M 1013 TURBO GASKET	47
0420 9205	0680 1805	BF6M 1013 TURBO GASKET	47
0420 9206	0680 1804	BF4M 1013 / BF6M 1012 TURBO GASKET	47
0420 9891	0680 1219	BF4M 1012 CYLINDER HEAD GASKET - 1 NOTCH	33
0420 9892	0680 1218	BF4M 1012 CYLINDER HEAD GASKET - 2 NOTCH	33
0420 9893	0680 1217	BF4M 1012 CYLINDER HEAD GASKET - 3 NOTCH	33
0420 9895	0680 1215	BF6M 1012 CYLINDER HEAD GASKET - 1 NOTCH	33
0420 9896	0680 1214	BF6M 1012 CYLINDER HEAD GASKET - 2 NOTCH	33
0420 9897	0680 1213	BF6M 1012 CYLINDER HEAD GASKET - 3 NOTCH	33
0422 0148	0688 0962	BFM 1015 INTAKE MANIFOLD GASKET	44
0422 1064	0688 9046	BFL 1015 VALVE COVER GASKET	42
0422 2904	0688 8106	BFL 1015 CYLINDER HEAD GASKET - 1 NOTCH	34
0422 2906	0688 8104	BFL 1015 CYLINDER HEAD GASKET - 2 NOTCH	34
0422 2908	0688 8102	BFL 1015 CYLINDER HEAD GASKET - 3 NOTCH	34
0422 3020	0688 7080	BFM 1015 EXHAUST MANIFOLD GASKET	45
0422 4081	0688 6029	BFL 1015 VALVE COVER GASKET	42
0422 4392	0688 6718	BFL 1015 VALVE COVER GASKET	42
0423 1432	0687 9678	FL 912/913 SHIM 0,50mm	52
0423 3529	0687 7581	FL 511/912/913/914 EXHAUST MANIFOLD GASKET (NEW TYPE)	45
0423 4001	0687 6009	FL 914 VALVE COVER GASKET	43
0425 2237	0685 8873	TCD 2013 OIL RADIATOR COVER RUBBER	50
0425 2397	0685 8713	TCD 2013 OIL RADIATOR RUBBER	50
0425 2902	0685 8108	TCD 2013 OIL RADIATOR RUBBER	51
0425 4803	0685 6207	BFM 2012 OIL RADIATOR COVER GASKET	48
0426 3576	0684 7534	BF6M 1015 / TCD6V 2015 OIL PAN GASKET	40
0426 3578	0684 7534	BF8M 1015 / TCD8V 2015 OIL PAN GASKET	40
0426 4004	0684 6006	BFL 1015 CYLINDER HEAD GASKET (NEW MODEL) - 1 NOTCH	34
0426 4005	0684 6005	BFL 1015 CYLINDER HEAD GASKET (NEW MODEL) - 2 NOTCH	34
0426 4006	0684 6004	BFL 1015 CYLINDER HEAD GASKET (NEW MODEL) - 3 NOTCH	34



www.eurogasket.com.tr

INDEX PAGE

To Fit
DEUTZ

OEM Part Number	Eurogasket Part Number	Description	Page Number
0427 1076	0683 9034	F4L 2011 VALVE COVER GASKET	43
0428 0463	0682 0647	BF3M 2011 VALVE COVER GASKET	43
0428 0808	0682 0202	F2L 2011 CYLINDER HEAD GASKET - 1 NOTCH	34
0428 0809	0682 0201	F2L 2011 CYLINDER HEAD GASKET - 2 NOTCH	34
0428 0810	0682 0290	F2L 2011 CYLINDER HEAD GASKET - 3 NOTCH	34
0428 0812	0682 0298	F3L 2011 CYLINDER HEAD GASKET - 1 NOTCH	34
0428 0813	0682 0297	F3L 2011 CYLINDER HEAD GASKET - 2 NOTCH	34
0428 0814	0682 0296	F3L 2011 CYLINDER HEAD GASKET - 3 NOTCH	34
0428 0816	0682 0294	F4L 2011 CYLINDER HEAD GASKET - 1 NOTCH	35
0428 0817	0682 0293	F4L 2011 CYLINDER HEAD GASKET - 2 NOTCH	35
0428 0818	0682 0292	F4L 2011 CYLINDER HEAD GASKET - 3 NOTCH	35
0428 3299	0682 7811	BFM 1012/1013/2012 EXHAUST MANIFOLD GASKET	45
0428 3391	0682 7719	BF4M 1012 VALVE COVER GASKET (METAL)	42
0428 5283	0682 5827	BF6M 2012 CYLINDER HEAD GASKET - 1 NOTCH	35
0428 5284	0682 5826	BF6M 2012 CYLINDER HEAD GASKET - 2 NOTCH	35
0428 5285	0682 5825	BF6M 2012 CYLINDER HEAD GASKET - 3 NOTCH	35
0428 6584	0682 4526	F3L 2011 CYLINDER HEAD GASKET (METAL) - 1 NOTCH	34
0428 6585	0682 4525	F3L 2011 CYLINDER HEAD GASKET (METAL) - 2 NOTCH	34
0428 6586	0682 4524	F3L 2011 CYLINDER HEAD GASKET (METAL) - 3 NOTCH	34
0428 7425	0682 3685	F4L 2011 CYLINDER HEAD GASKET (METAL) - 1 NOTCH	35
0428 7426	0682 3684	F4L 2011 CYLINDER HEAD GASKET (METAL) - 2 NOTCH	35
0428 7427	0682 3683	F4L 2011 CYLINDER HEAD GASKET (METAL) - 3 NOTCH	35
0428 9403	0682 1607	TCD6L 2012 2V CYLINDER HEAD GASKET - 3 NOTCH	35
0428 9404	0682 1606	TCD6L 2012 2V CYLINDER HEAD GASKET - 2 NOTCH	35
0428 9405	0682 1605	TCD6L 2012 2V CYLINDER HEAD GASKET - 1 NOTCH	35
0428 9406	0682 1604	BF4M 2012/TCD4L 2012 2V CYLINDER HEAD GASKET - 3 NOTCH	35
0428 9407	0682 1603	BF4M 2012/TCD4L 2012 2V CYLINDER HEAD GASKET - 2 NOTCH	35
0428 9408	0682 1602	BF4M 2012/TCD4L 2012 2V CYLINDER HEAD GASKET - 1 NOTCH	35
0429 1418	0681 9692	TCD6L 2012 2V VALVE COVER GASKET	43
0429 1468	0681 9642	TCDL 2013 2V VALVE COVER GASKET	43
0429 2820	0681 8280	TCD 2013 EXHAUST MANIFOLD GASKET	45
0429 4194	0681 6916	TCD6L 2013 2V CYLINDER HEAD GASKET - 1 NOTCH	36
0429 4195	0681 6915	TCD6L 2013 2V CYLINDER HEAD GASKET - 2 NOTCH	36
0429 4196	0681 6914	TCD6L 2013 2V CYLINDER HEAD GASKET - 3 NOTCH	36
0496 0420	0614 0680	F6L 614 FULL SET GASKET	19
0596 0420	0514 0680	F6L 514 FULL SET GASKET	19
0596 0620	0514 0480	F4L 514 FULL SET GASKET	19
0596 0720	0514 0380	F3L 514 FULL SET GASKET	19
1214 1862	9896 9248	TURBO GASKET	46
1227 0150	9883 0950	GASKET	49
1227 5302	9883 5708	TBD 616 SEALING RING	54
1227 5412	9883 5698	GASKET	49
1227 7677	9883 3433	VALVE COVER GASKET	43
1227 7914	9883 3196	GASKET	49
1230 5008	9870 5002	SHIM 0,25mm	53
1231 4060	9879 6040	SHIM	53



www.eurogasket.com.tr

INDEX PAGE

To Fit
IVECO

OEM Part Number	Eurogasket Part Number	Description	Page Number
190 2260	910 8840	MOT 8200.02.220 FULL SET GASKET	59
190 78 53	910 32 57	MOT 8060.25 R-U / MOT 8060.45 B-L-M FULL SET GASKET	59
190 78 67	910 23 43	MOT 8040.05 - 50.9-65.9 ZETA FULL SET GASKET	60
190 7811	910 3299	MOT8060.25 R-U/MOT8060.45 B-L-M OIL PAN GASKET	65
190 7832	910 3278	3455CC CYLINDER HEAD GASKET	62
190 7835	910 3275	65E12 EUROCARGO CYLINDER HEAD GASKET	62
190 7939	910 3171	4 CYLINDER Ø104 HEAD SET GASKET	61
190 7960	910 3140	MOT 8210.42-22 /330.36/330.30/190.36/190.33 HEAD SET GASKET	61
190 80 16	910 20 94	6 CYLINDER Ø120 FULL SET GASKET	60
190 8023	910 2087	TURBO 9500CC HEAD SET GASKET	61
190 8047	910 2063	6 CYLINDER Ø122 HEAD SET GASKET	61
190 8052	910 2058	6 CYLINDER Ø130 X 145 FULL SET GASKET	58
190 86 91	910 24 19	MOT 8210.42 L.U.K EUROTECH/EUROSTAR/EUROTRAKKER FULL SET	60
190 88 81	910 22 29	MOT 8210.22 / 330.30 TURBO / 190.33 TURBO STAR FULL SET GASKET	59
190 88 82	910 22 28	MOT 8210.02 697 N FULL SET GASKET	59
190 8818	910 2292	EUROTECH/EUROSTAR HEAD SET GASKET	61
190 8885	910 2225	6 CYLINDER Ø137 FULL SET GASKET	58
45 38 800	65 72 200	MOT 8200.02 / 684 N-T OIL PAN GASKET	65
46 59 146	64 51 964	MOT 8200.02 684 NT CYLINDER HEAD GASKET	63
465 9146	645 1964	3 CYLINDER Ø122 CYLINDER HEAD GASKET	63
4745 908	6365 102	MOT 8210.02 697N CYLINDER HEAD GASKET	63
479 1426	631 9684	MOT 8210.02 / 697N OIL PAN GASKET	65
479 1426	631 9684	MOT 8210.22-42 OIL PAN GASKET	65
48 39 530	62 71 570	MOT8210-22/ 42 TURBOSTAR EXHAUST MANIFOLD GASKET	67
486 2513	624 8597	Ø145 CYLINDER HEAD GASKET	62
486 8470	624 2630	3 CYLINDER Ø125 CYLINDER HEAD GASKET	62
486 8477	624 2633	3 CYLINDER Ø130 X 145 CYLINDER HEAD GASKET	62
613 19 208	497 91 802	MOT8460.21 B-R/MOT8460.41 T-C-A EXHAUST MANIFOLD GASKET	67
613 19085	497 91025	3 CYLINDER Ø120 CYLINDER HEAD GASKET	64
613 20 224	497 80 886	MOT 8460.21 B-R/MOT 8460.41 T-C-A OIL PAN GASKET	65
613 21 089	497 89 021	MOT8460.21 B-R/MOT8460.41 F-C-A INTAKE MANIFOLD GASKET	66
984 09 494	126 01 616	EUROTECH/EUROSTAR/EUROTRAKKER EXHAUST MANIFOLD GASKET	67
99 444 980	11 666 120	MOT 8210.22/42 TURBOSTAR INTAKE MANIFOLD GASKET	66
994 40 847	116 60 263	EUROTECH/EUROSTAR/EUROTRAKKER INTAKE MANIFOLD GASKET	66
994 65715	116 45395	EUROTECH/EUROSTAR CYLINDER HEAD GASKET	63
9946 0467	1164 0643	MOT 8210.42 L.U.K EUROTECH/EUROSTAR/EUROTRAKKER CYL.HEAD	63
9948 4354	1162 6756	3 CYLINDER Ø137 CYLINDER HEAD GASKET	64
	0082 100	65E12 EUROCARGO HEAD SET GASKET	58
	0081 500	EUROTECH/EUROSTAR FULL SET GASKET	58
	0082 000	6 CYLINDER Ø125 FULL SET GASKET	58
	0081 100	8 CYLINDER Ø145 FULL SET GASKET	59



www.eurogasket.com.tr

INDEX PAGE

To Fit
MAN

OEM Part Number	Eurogasket Part Number	Description	Page Number
51 00900 6125	59 00100 4985	2146/2156	74
51 00900 6156	59 00100 4954	D2356 FULL SET GASKET	73
51 00900 6204	59 00100 4806	D2156 FULL SET GASKET	72
51 00900 6398	59 00100 4712	2866 FULL SET GASKET COPPER METAL	73
51 00900 6398	59 00100 4712	2866 FULL SET GASKET RUBBER METAL	73
51 00900 6404	59 00100 4606	D0226 FULL SET GASKET	72
51 00900 6424	59 00100 4686	D0224-D0226 HEAD SET GASKET	75
51 00900 6457	59 00100 4653	2566 FULL SET GASKET	73
51 00900 6528	59 00100 4582	D0224 FULL SET GASKET	72
51 00900 6531	59 00100 4579	D0826 FULL SET GASKET	72
51 00900 6550	59 00100 4550	D0824-D0826 HEAD SET GASKET	75
51 00900 6558	59 00100 4552	D2866 HEAD SET GASKET	76
51 00900 6558	59 07109 0754	D2840-2842-2866 HEAD SET GASKET	76
51 00900 6570	59 00100 4530	2530-2555-2566 HEAD SET GASKET	75
51 00900 6577	59 00100 4533	D0824 FULL SET GASKET	72
51 00900 6591	59 00100 4519	2356/IKARUS (RUBBER METAL-COPPER METAL)	74
51 00900 6602	59 00100 4408	D2566-2866 CONVERSION SET	74
51 00900 6603	59 00100 4407	D2866 CONVERSION SET	74
51 00900 6629	59 00100 4481	2538 ME HEAD SET GASKET	75
51 00900 6629	59 00100 4481	D2866 HEAD SET GASKET	76
51 00900 6630	59 00100 4470	28664V- 28764V HEAD SET GASKET	76
51 00900 6652	59 00100 4458	28764V FULL SET GASKET	74
51 00900 6652	59 00100 4458	28764V HEAD SET GASKET	76
51 00900 6680	59 00100 4420	D2066 FULL SET GASKET	73
51 00900 6681	59 00100 4429	D2066 HEAD SET GASKET	75
51 01222 0001	59 09888 0009	SHIM	89
51 01222 0002	59 09888 0008	SHIM	89
51 01903 0251	59 09107 0859	2530-2538-2540-2542-2555-2556-2565-2566-2840 BLOCK COVER GASKET	85
51 01903 0252	59 09107 0858	2565-2866 FLYWHEEL GASKET	85
51 01905 0092	59 09105 0018	2066 TIMING CASE COVER GASKET	86
51 03901 0260	59 07109 0840	D2146 HM1U - D2156 HMXU	78
51 03901 0263	59 07109 0847	D2156 CYLINDER HEAD GASKET	77
51 03901 0264	59 07109 0846	D2356 CYLINDER HEAD GASKET	77
51 03901 0286	59 07109 0824	D0224-D0226 CYLINDER HEAD GASKET	77
51 03901 0298	59 07109 0812	D2866 CYLINDER HEAD GASKET	78
51 03901 0338	59 07109 0772	28764V CYLINDER HEAD GASKET	78
51 03901 0342	59 07109 0768	2530MF / 2555 / 2556 CYLINDER HEAD GASKET	78
51 03901 0356	59 07109 0754	D2866 CYLINDER HEAD GASKET	78
51 03901 0379	59 07109 0731	D0824-D0826-D0836LF CYLINDER HEAD GASKET	77
51 03901 0403	59 07109 0607	D2066 CYLINDER HEAD GASKET	77
51 03905 0099	59 07105 0011	D2156-2356 VALVE COVER GASKET	81
51 03905 0135	59 07105 0975	D2566-2866 VALVE COVER GASKET	81
51 03905 0135	59 07105 0975	D2566-2866 VALVE COVER GASKET - SILICONED	81
51 03905 0148	59 07105 0962	D0226-0826 VALVE COVER GASKET	81
51 03905 0155	59 07105 0955	D0226-0826 VALVE COVER GASKET - METAL	81
51 03905 0157	59 07105 0953	D2866 4V - 2876 4V VALVE COVER GASKET	81
51 03905 0177	59 07105 0933	D2066 VALVE COVER GASKET	81
51 05901 0119	59 05109 0991	2566-2866 OIL COOLER GASKET	85
51 05901 0122	59 05109 0988	2866 4V-2876 4V OIL COOLER GASKET	85
51 05901 0131	59 05106 0979	D2555-2565-2865 OIL PAN GASKET	80
51 05901 0137	59 05109 0973	2066 GASKET	86
51 05904 0101	59 0106 0096	D2156-2356 OIL PAN GASKET	79
51 05904 0132	59 05106 0978	D2566-D2866 OIL PAN GASKET	80
51 05904 0132	59 051060978-1	D2566-D2866 OIL PAN GASKET	80
51 05904 0139	59 05106 0971	D0226-D0826 OIL PAN GASKET	79
51 05904 0171	59 05106 0939	D0224-D0824 OIL PAN GASKET	79



www.eurogasket.com.tr

INDEX PAGE

To Fit
MAN

OEM Part Number	Eurogasket Part Number	Description	Page Number
51 05904 0189	59 05106 0921	D2876 OIL PAN GASKET	80
51 05904 0204	59 05106 0806	D2066 OIL PAN GASKET	79
51 05904 0212	59 05106 0898	D2066 OIL PAN GASKET	79
51 06901 0147	59 04109 0963	2566-2866 WATER PUMP GASKET	85
51 06901 0192	59 04109 0918	2066 WATER PUMP GASKET	86
51 06903 0061	59 04107 0049	2066 WATER PUMP GASKET	86
51 06904 0039	59 04106 0071	2066 THERMOSTAT GASKET	87
51 06904 0042	59 04106 0068	2066 THERMOSTAT GASKET	86
51 08901 0023	59 02109 0087	D2566-2866 EXHAUST MANIFOLD GASKET	83
51 08901 0027	59 02109 0083	D0226-D0826 EXHAUST MANIFOLD GASKET	83
51 08901 0120	59 02109 0980	2066 GASKET	88
51 08901 0150	59 02109 0950	TURBO GASKET	84
51 08901 0152	59 02109 0958	D2866-2876 EXHAUST MANIFOLD GASKET	83
51 08901 0172	59 02109 0938	2066 GASKET	87
51 08901 0174	59 02109 0936	2066 GASKET	87
51 08901 0182	59 02109 0928	2066 TURBO GASKET	84
51 08901 0195	59 02109 0915	2066 GASKET	87
51 08901 0206	59 02109 0804	D2066 EXHAUST MANIFOLD GASKET	83
51 08901 0209	59 02109 0801	2066 TURBO GASKET	84
51 08901 0209-1	59 02109 0801-9	2066 TURBO GASKET	84
51 08901 0930	59 02109 0930	D2066 EXHAUST MANIFOLD GASKET	83
51 08902 0006	59 02108 0004	D2156-2366 INTAKE MANIFOLD GASKET	82
51 08902 0121	59 02108 0989	D0226-D0826 INTAKE MANIFOLD GASKET	82
51 08902 0155	59 02108 0955	D2876 4V INTAKE MANIFOLD GASKET	82
51 08902 0161	59 02108 0949	D2566-D2866 INTAKE MANIFOLD GASKET	82
51 15901 0012	59 95109 0012	TGA TURBO GASKET	84
51 96501 0263	59 14509 0847	RUBBER	90
51 96501 0338	59 14509 0772	RUBBER	90
51 96501 0346	59 14509 0764	RUBBER	90
51 98701 0068	59 12309 0042	D2156-2356 EXHAUST MANIFOLD GASKET	83
51 98701 0120	59 12309 0980	D2066 EXHAUST MANIFOLD RING	83
51 98701 0139	59 12309 0971	2066 COPPER WASHER	87
906 601 0776	104 409 0334	2066 GASKET	88
	26452	RUBBER SET	90
	12812	RUBBER SET	90
	13161	RUBBER SET	90
	50263	RUBBER SET	90
	906993	RUBBER SET	90
	13150	RUBBER SET	90



www.eurogasket.com.tr

INDEX PAGE

To Fit
M.BENZ

OEM Part Number	Eurogasket Part Number	Description	Page Number
000 586 0426	000 524 0684	OM 355 GEAR BOX GASKET	130
009 997 8848	001 113 2262	OM 401-402-403-404-407 LINER RUBBER	134
012 997 7148	098 113 3962	OM 401-402-403-404-407 LINER RUBBER	134
015 997 9048	095 113 1062	LINER RUBBER	134
015 997 9148	095 113 1962	LINER RUBBER	134
025 997 8448	085 113 2662	OM 422 LINER RUBBER	134
025 997 8548	085 113 2562	OM 422 LINER RUBBER	134
070 952 0713	030 158 0397	GASKET	129
1269 298 933	9841 812 177	GEAR BOX GASKET	130
1295 298 915	9815 812 195	16S GEAR BOX GASKET	130
201 1080	809 9020	OM 442 WATER PUMP GASKET	132
312 492 1080	798 618 9020	OM 314-352 GLANDULAR GASKET	123
314 010 0280	796 090 0820	OM 314-364 OIL PAN GASKET	114
314 010 0480	796 090 0620	OM 314 FULL SET GASKET	99
314 010 6020	796 090 4080	OM 314 HEAD SET GASKET	108
314 016 0321	796 094 0789	OM 314 VALVE COVER GASKET	119
314 142 0380	796 968 0720	OM 314 EXHAUST MANIFOLD GASKET	122
327 010 4027	783 090 6083	OM 327 FULL SET GASKET	99
327 016 0820	783 094 0280	OM 327 CYLINDER HEAD GASKET	110
345 142 0080	765 968 0020	OM 346-355 EXHAUST MANIFOLD GASKET	122
346 015 0120	764 095 0980	OM 355 TIMING CASE GASKET	127
346 016 0320	764 094 0780	OM 346 CYLINDER HEAD GASKET	110
346 356 0073	764 754 0037	OM 346 GASKET	128
346 586 0290	764 524 0810	OM 346 FULL SET GASKET	99
352 010 0880	758 090 0220	OM 352-366 OIL PAN GASKET	114
352 010 2621	758 090 8489	OM 352 HEAD SET GASKET	108
352 015 0320	758 095 0780	OM 352 TIMING CASE GASKET	125
352 015 0522	758 095 0588	OM 352 SIDE COVER GASKET	126
352 016 0921	758 094 0189	OM 352 VALVE COVER GASKET	119
352 142 0480	758 968 0620	OM 352 EXHAUST MANIFOLD GASKET	122
352 188 0880	758 922 0220	OM 352 OIL COOLER GASKET	126
352 201 2180	758 809 8920	O 302 UNIMOG WATER PUMP GASKET	133
352 586 1190	758 524 9910	OM 352 FULL SET GASKET	99
355 010 0027	755 090 0083	OM 355 OIL PAN GASKET	114
355 010 1220	755 090 9880	OM 355 HEAD SET GASKET	108
355 015 0021	755 095 0089	OM 355 OIL COOLER GASKET	127
355 016 0021	755 094 0089	OM 355 VALVE COVER GASKET	119
355 016 0420	755 094 0680	OM 355 CYLINDER HEAD GASKET	110
355 141 0280	755 969 0820	OM 346-355 INTAKE MANIFOLD GASKET	121
355 586 0390	755 524 0710	OM 355 FULL SET GASKET	99
360 010 3320	740 090 7780	OM 360 HEAD SET GASKET	108
360 010 4020	740 090 6080	OM 360 FULL SET GASKET	100
360 014 0322	740 096 0788	OM 360 OIL PAN GASKET	114
360 016 0221	740 094 0889	OM 360 VALVE COVER GASKET	119
360 016 0320	740 094 0780	OM 360 CYLINDER HEAD GASKET	111
360 141 0180	740 969 0920	OM 360 INTAKE MANIFOLD GASKET	121
360 142 0380	740 968 0720	OM 360 EXHAUST MANIFOLD GASKET	122
364 010 4020	746 090 6080	OM 364 FULL SET GASKET	100
364 010 4020	746 090 6080	OM 364 HEAD SET GASKET	108
364 015 0180	746 095 0920	OM 314-364 OIL PAN GASKET	114
364 015 0360	746 095 0740	OM 364 GASKET - RUBBER	128
364 016 0121	746 094 0989	OM 364 VALVE COVER GASKET	119
364 016 0720	746 094 0380	OM 314 CYLINDER HEAD GASKET	110
364 016 0720	746 094 0380	OM 364 CYLINDER HEAD GASKET	111
366 010 0680	744 090 0420	OM 366 OIL PAN GASKET	115
366 010 4408	744 090 6602	OM 366 GASKET SET	106



www.eurogasket.com.tr

INDEX PAGE

To Fit
M.BENZ

OEM Part Number	Eurogasket Part Number	Description	Page Number
366 010 6120	744 090 4980	OM 366 HEAD SET GASKET	109
366 015 0060	744 095 0040	OM 366 BLOCK COVER GASKET	127
366 016 0321	744 094 0789	OM 366 VALVE COVER GASKET	119
366 016 0620	744 094 0480	OM 352 CYLINDER HEAD GASKET	110
366 016 0620	744 090 0480	OM 366 CYLINDER HEAD GASKET	111
366 141 0780	744 969 0320	OM 364-366 INTAKE MANIFOLD GASKET	121
366 142 0880	744 968 0220	OM 364-366 EXHAUST MANIFOLD GASKET	122
366 184 0080	744 926 0020	OM 366 OIL FILTER GASKET	129
366 188 0280	744 922 0820	OM 352 OIL COOLER GASKET	126
366 201 0480	744 809 0620	OM 366 WATER PUMP GASKET - METAL	132
366 586 1290	744 090 4980	OM 366 FULL SET GASKET	100
389 268 2080	721 842 8020	METAL GASKET	129
389 268 2180	721 842 8920	METAL GASKET	129
401 586 5090	609 524 5010	OM 401 FULL SET GASKET	100
402 586 5090	608 524 5010	OM 402 FULL SET GASKET	100
403 016 0061	607 094 0049	OM 401-402-403-407-421-422-423-427-441-442-447 INJECTOR RUBBER	134
403 016 0321	607 094 0789	OM 403 VALVE COVER GASKET	119
403 053 0196	607 057 0914	OM 401-402-403-407-421-422-423-427-441-442-447 PUSHROD SEAL	134
403 142 0380	607 968 0720	OM 401-402-403-421-422-441-447 EXHAUST MANIFOLD GASKET	122
403 586 5090	607 524 5010	OM 403 FULL SET GASKET	101
404 586 5090	606 524 5010	OM 404 FULL SET GASKET	101
407 586 5090	603 524 5010	OM 407 FULL SET GASKET	101
421 010 0408	689 090 0602	OM 401-421-441 CONVERSION SET	106
421 142 0180	689 968 0920	OM 421-441-442 TURBO GASKET	124
421 142 0180	689 968 0920	OM 421-441-442 TURBO GASKET SET	124
421 586 5090	689 524 5010	OM 421 FULL SET GASKET	101
422 016 0320	688 094 0780	OM 401-402 CYLINDER HEAD GASKET	111
422 016 0320	688 094 0780	OM421-422-441-442-444-447 CYLINDER HEAD GASKET - RUBBER METAL	112
422 016 0620	688 094 0480	OM401-402-403-407 CYLINDER HEAD GASKET	111
422 016 0620	668 094 0480	OM 427 CYLINDER HEAD GASKET	112
422 016 0620	688 094 0480	OM421-422-441-442-444-447 CYLINDER HEAD GASKET - COPPER METAL	112
422 142 0080	688 968 0020	OM 366-401-402-422-441-442 TURBO GASKET	124
422 142 0080	688 968 0020	OM 422-442 TURBO GASKET SET	124
422 144 0280	688 966 0820	OM 422-442 TURBO GASKET	124
422 586 5090	688 524 5010	OM 422 FULL SET GASKET	102
422 586 5090	688 524 5010	OM 422 A/LA FULL SET GASKET	102
423 010 0608	687 090 0402	OM 402-422-442 CONVERSION SET	106
423 010 4883	687 090 6227	FLYWHEEL HOUSING SET	125
423 011 0259	687 099 0851	OM 423 LINER RUBBER	134
423 042 0080	687 068 0020	TURBO GASKET SET	124
423 586 5090	687 524 5010	OM 423 FULL SET GASKET	102
427 586 5090	683 524 5010	OM 427 FULL SET GASKET	102
441 014 0022	669 096 0088	OM 401-421-441 OIL PAN GASKET	115
441 014 0022	669 096 0088	OM 401-421-441 OIL PAN GASKET - SILICONED	115
441 586 5090	669 524 5010	OM 441 FULL SET GASKET	102
441 586 5090	669 524 5010	OM 441 LA FULL SET GASKET	103
442 011 0080	668 099 0020	OM 442 CAMSHAFT COVER GASKET	125
442 014 0222	668 096 0888	OM 402-422-442 OIL PAN GASKET- SLICONED	115
442 014 0222	668 096 0888	OM 402-422-442 OIL PAN GASKET	115
442 014 1122	668 096 9988	OM 402-422-442 OIL PAN GASKET - 4PCS	116
442 015 0060	668 095 0040	OM 442 SWALLOW RUBBER	125
442 016 0320	668 094 0780	OM 427 CYLINDER HEAD GASKET - RUBBER METAL	112
442 016 0420	668 094 0680	OM 423 CYLINDER HEAD GASKET	112
442 016 0621	668 094 0489	OM 442 VALVE COVER GASKET - SILICONED	119
442 016 0621	668 094 0489	OM 442 VALVE COVER GASKET - METAL	119
442 018 0080	668 092 0020	OM 442 GASKET	123



www.eurogasket.com.tr

INDEX PAGE

To Fit
M.BENZ

OEM Part Number	Eurogasket Part Number	Description	Page Number
442 141 0780	668 969 0320	OM 442 SUCTION GASKET	125
442 141 1780	668 969 9320	OM401-402-403-421-422-441-447 INTAKE MANIFOLD GASKET	121
442 184 0480	668 926 0620	OM 442 TURBO GASKET	124
442 184 0580	668 926 0520	OM 442 OIL COOLER GASKET	131
442 187 0080	668 923 0020	OM 366-401-402-422-441-442 TURBO GASKET	124
442 187 0180	668 923 0920	OM 366-401-402-422-441-442 TURBO GASKET	124
442 188 0580	668 922 0520	OM 422 OIL COOLER GASKET	131
442 201 0080	668 809 0020	OM 401-402-403-404 WATER PUMP GASKET	132
442 492 0080	668 618 0020	UNIMOG O-303 GLANDULAR GASKET	123
442 586 5090	668 524 5010	OM 442 FULL SET GASKET	103
442 586 5090	668 524 5010	OM 442 LA FULL SET GASKET	103
443 014 0022	667 096 0088	OM 403-423-443 OIL PAN GASKET - SILICONED	116
443 014 0022	667 096 0088	OM 403-423-443 OIL PAN GASKET	116
443 586 5090	667 524 5010	OM 443 LA FULL SET GASKET	103
444 010 0120	666 090 0980	OM401-402-403-404-407-421-422-423-441-442 HEAD SET GASKET-RUBBER	109
444 010 0120	666 090 0980	OM401-402-403-404-407-421-422-423-441-442 HEAD SET GASKET-COPPER	109
444 014 0022	666 096 0088	OM 404-424-444 OIL PAN GASKET	116
444 586 5090	666 524 5010	OM 444 LA FULL SET GASKET	103
447 014 0024	663 096 0086	OM 457 OIL PAN GASKET	116
447 015 0080	663 095 0020	OM 407-447 TIMING CASE GASKET	129
447 586 5090	663 524 5010	OM 447 FULL SET GASKET	104
457 010 0105	653 090 0905	OM 457 LA/HLA FULL SET GASKET	104
457 010 0105	653 090 0905	OM 457 CONVERSION SET	106
457 010 7320	653 090 3780	OM 457 HEAD SET GASKET	109
457 016 0021	653 094 0089	OM 457 VALVE COVER GASKET	119
457 016 0121	653 094 0989	OM 457 VALVE COVER GASKET - RUBBER	120
457 016 1120	688 094 0480	OM 457 CYLINDER HEAD GASKET	113
457 141 0080	653 969 0020	OM 457 INTAKE MANIFOLD GASKET	121
541 010 0225	569 090 0885	OM 501 CONVERSION SET	106
541 010 0505	569 090 9705	OM 501 LA - OM 541 FULL SET GASKET	104
541 010 0933	569 090 0177	OM 501-502 FLYWHEEL HOUSING SET	126
541 010 1120	569 090 9980	OM 501-502 HEAD SET GASKET	109
541 011 0180	569 099 0920	OM 501-502 CAMSHAFT COVER GASKET	127
541 014 0322	569 096 0788	OM 501 OIL PAN GASKET	117
541 014 0522	569 096 0588	OM 501 OIL PAN GASKET - RUBBER	117
541 015 0160	569 095 0940	OM 501-502 TIMING CASE GASKET	127
541 016 0321	569 094 0789	OM 501-502 VALVE COVER GASKET - RUBBER	120
541 016 0920	569 094 0180	OM 501-502 CYLINDER HEAD GASKET	113
541 098 0480	569 012 0620	OM 501-502 INTAKE MANIFOLD GASKET	121
541 142 0280	569 968 0820	OM 457-501-502 EXHAUST MANIFOLD GASKET	122
541 184 0780	569 926 0320	OM 501-502 OIL COOLER GASKET	126
541 997 0945	569 113 0165	OM 502 LA ACTROS	134
542 010 0205	568 090 0805	OM 502 CONVERSION SET	107
542 010 0405	568 090 0605	OM 502 LA FULL SET GASKET	104
542 014 0322	568 096 0788	OM 502 OIL PAN GASKET	117
542 201 0180	568 809 0920	OM 501-502 WATER PUMP GASKET	132
542 201 0180	568 809 0920	OM 501-502 WATER PUMP GASKET - METAL	133
601 238 0780	409 872 0320	OM 601 WATER PUMP GASKET - METAL	133
611 201 0280	499 809 0820	OM 611-612-646 WATER PUMP GASKET - METAL	133
650 356 0080	450 754 0020	ACTROS GEAR BOX GASKET	130
650 356 0180	450 754 0920	ACTROS-ATEGO GEAR BOX GASKET	130
706 402 70	304 608 30	ADE 422 BOTTOM SET	107
706 402 83	304 608 27	ADE 407 BOTTOM SET	107
904 010 4505	106 090 6505	OM 904 CONVERSION SET	107
904 014 0622	106 096 0488	OM 904 LA OIL PAN GASKET	117
904 016 0621	109 094 0489	OM 904 LA VALVE COVER GASKET - RUBBER	120



www.eurogasket.com.tr

INDEX PAGE

To Fit
M.BENZ

OEM Part Number	Eurogasket Part Number	Description	Page Number
904 016 0622	106 094 0488	OM 904 LA OIL PAN GASKET - RUBBER	117
904 016 1020	106 094 9080	OM 904 LA FULL SET GASKET	104
904 016 1320	106 094 9780	OM 904 LA CYLINDER HEAD GASKET	113
904 184 0280	106 926 0820	OM 904 LA GASKET	128
906 010 4505	104 090 6505	OM 906 LA FULL SET GASKET	105
906 010 4505	104 090 6505	OM 906 CONVERSION SET	107
906 014 0622	104 096 0488	OM 906 LA OIL PAN GASKET - RUBBER	118
906 014 0922	104 096 0188	OM 906 LA OIL PAN GASKET	118
906 016 0621	104 094 0489	OM 906 LA VALVE COVER GASKET - RUBBER	120
906 016 0721	104 094 0389	OM 906 LA VALVE COVER GASKET	120
906 016 1420	104 094 9680	OM 906 LA CYLINDER HEAD GASKET	113
906 141 0180	104 969 0920	OM 906 LA INTAKE MANIFOLD GASKET	121
906 142 0280	104 968 0820	OM 906 LA EXHAUST MANIFOLD GASKET	122
906 188 0280	104 922 0820	OM 906 LA OIL COOLER GASKET	128
906 201 0080	104 809 0020	OM 904-906 LA WATER PUMP GASKET	132
914 975	196 135	OM 402 A/LA FULL SET GASKET	101
942 501 0080	168 509 0020	OM 501-502 WATER PUMP GASKET	133
	400 754 0037	OM 400 GASKET	128
		OM 401-402-403-407 LINER RUBBER KIT	135
		LINER RUBBER KIT	135
		LINER RUBBER RING KIT	135
		ACTROS LINER RUBBER RING KIT	135
		OM 457 LA LINER RUBBER RING KIT	135



www.eurogasket.com.tr

INDEX PAGE

To Fit
RENAULT RVI

OEM Part Number	Eurogasket Part Number	Description	Page Number
5000 670 202	5000 430 808	RVI BERLIT-KERAX-PREMIUM CYLINDER HEAD GASKET	140
5000 678 639	5000 432 471	RVI BERLIT-MAGNUM CYLINDER HEAD GASKET	140
5000 793 222	5000 317 888	MIDR/S-MIPR/S HEAD SET GASKET	138
5000 793 734	5000 317 376	MDS 6BH12 HEAD SET GASKET	138
5001 175 834 578	5009 935 276 532	PREMIUM-KERAX HEAD SET GASKET	138
5001 175 857 432	5009 935 253 678	PREMIUM-KERAX HEAD SET GASKET	138
5001 180 858 729	5009 920 252 381	MIDLUM-PREMIUM CONVERSION SET	137
5001 180 858 729	5009 920 276 531	PREMIUM-KERAX CONVERSION SET	137
5001 180 866 494	5009 920 244 616	PREMIUM-KERAX CONVERSION SET	137
5001 825 563	5009 285 547	MIDR 06 35.40C R SERIES HEAD SET GASKET	139
5001 830 802	5009 270 208	MAGNUM HEAD SET GASKET	138
5001 847 781	5009 263 329	RVI BERLIT-MAJOR CYLINDER HEAD GASKET	140
5001 866 493	5009 244 617	HEAD SET GASKET	139
702 0495 935	308 0615 175	CYLINDER HEAD AGSKET	140



www.eurogasket.com.tr

INDEX PAGE

To Fit
SCANIA

OEM Part Number	Eurogasket Part Number	Description	Page Number
551 416	559 694	DS8 FULL SET GASKET	143
1 101 276	9 909 834	DS11 GASKET	156
1 109 288	9 901 822	DSC11 EXHAUST MANIFOLD GASKET	154
1 301 629	9 709 481	DS11 -DSC11 INTAKE MANIFOLD GASKET	153
1 302 930	9 708 170	DS11 TURBO GASKET	155
1 305 139	9 705 971	GEAR BOX GASKET	163
1 305 959	9 705 151	DS14-DSC14 VALVE COVER GASKET	151
1 309 051	9 701 059	DSC12 EXHAUST MANIFOLD GASKET	154
1 313 459	9 797 651	DS14 CYLINDER HEAD GASKET	148
1 320 992	9 780 118	DS14 GASKET	162
1 349 497	9 761 613	DC11-DC/DSC12 OIL COOLER GASKET	158
1 367 027	9 743 083	DSC12 VALVE COVER GASKET	151
1 367 028	9 743 082	DSC12 VALVE COVER GASKET	151
1 374 143	9 736 967	GASKET	161
1 374 326	9 736 784	DSC12 GASKET	158
1 374 327	9 736 783	4 SERIES FLYWHEEL HOUSING GASKET	159
1 374 344	9 736 766	DSC12 WATER PUMP GASKET	160
1 374 388	9 594 636-1	DSC 12 INTAKE MANIFOLD GASKET	153
1 375 383	9 735 727	DSC12 GASKET	158
1 384 554	9 726 556	DSC11 INTAKE MANIFOLD GASKET	153
1 388 682	9 722 428	4 SERIES/2-3 SERIES FLYWHEEL HOUSING GASKET	159
1 388 685	9 722 425	DS14 GASKET	161
1 390 211	9 710 899	4 SERIES - P/G/R/T SERIES INTAKE MANIFOLD GASKET	153
1 392 196	9 718 914	DS9-DS11-DS14 GASKET	157
1 392 927	9 718 183	DS14 GASKET	161
1 392 929	9 718 181	DS14 GASKET	161
1 392 930	9 718 170	DS14 GASKET	162
1 392 933	9 718 177	DS14 GASKET	160
1 393 937	9 717 173	DSC12 TURBO GASKET	155
1 401 984	9 609 126	DC12 - DT12 VALVE COVER GASKET	151
1 403 129	9 607 981	DC9-11/DC-DSC12 GASKET TIMING CASE	160
1 403 258	9 607 852	DS9 CYLINDER HEAD GASKET	147
1 403 260	9 607 840	DSC12 CYLINDER HEAD GASKET - OLD MODEL	147
1 411 851	9 699 259	DSC12-DC11-DC12-DT12 VALVE COVER GASKET	151
1 414 422	9 696 688	DSC12 VALVE COVER GASKET	151
1 468 555	9 642 555	DSC12 CYLINDER HEAD GASKET - NEW MODEL	147
1 476 506	9 634 504	DC11-12 VALVE COVER GASKET	151
1 484 765	9 626 345	DC9-11/DC-DSC12/DC16 OIL COOLER GASKET	159
1 484 766	9 626 344	DC9-11/DC-DSC12/DC16 OIL COOLER GASKET	159
1 502 798	9 508 312	DC9-11/DC-DSC 12 OIL COOLER GASKET	158
1 505 366	9 505 744	4 SERIES - P/G/R/T SERIES VALVE COVER GASKET	152
1 516 474	9 594 636	DSC 12 INTAKE MANIFOLD GASKET	153
1 539 692	9 571 418	4 SERIES/2-3 SERIES FLYWHEEL HOUSING GASKET	159
1 755 112	9 355 998	DC9-DC16 HEAD SET GASKET	146
1 865 674	9 245 436	4 SERIES - P/G/R/T SERIES OIL PAN GASKET	150
133 88 60	977 22 40	DS14 OIL COOLER GASKET	157
139 2932	971 8178	DS14 GASKET	157
139 2934	971 8176	DS14 GASKET	157
139 2935	971 8175	DS14 GASKET	157
231 795	879 315	DS11 WATER PUMP GASKET	156
257 381	853 729	DS8 CYLINDER HEAD GASKET	147
258 458	852 652	DS8 VALVE COVER GASKET	151
258 459	852 651	DS11 VALVE COVER GASKET	151
275 209	835 801	DS8 EXHAUST MANIFOLD GASKET	154
277 272	833 838	DS 11 EXHAUST MANIFOLD GASKET	154
277 273	833 837	DS11 EXHAUST MANIFOLD GASKET	154



www.eurogasket.com.tr

INDEX PAGE

To Fit
SCANIA

OEM Part Number	Eurogasket Part Number	Description	Page Number
277 632	833 478	DS11 INTAKE MANIFOLD GASKET	153
277 662	833 448	DS8 INTAKE MANIFOLD GASKET	153
291 826	819 284	DS11-DSC11 GASKET	156
295 275	815 835	DS11 GASKET	161
321 991	789 119	4 SERIES OIL COOLER GASKET	160
329 498	781 612	DS9-DSC9 INTAKE MANIFOLD GASKET	153
364 792	746 318	DS9 EXHAUST MANIFOLD GASKET	154
366 539	744 571	DN9-DS9-DSC9 OIL PAN GASKET	149
369 276	741 834	DS14 EXHAUST MANIFOLD GASKET	154
371 486	739 624	DS11 GASKET	156
371 486	739 624	DS11 FUEL PUMP GASKET	162
371 487	739 623	DS11 GASKET	162
371 503	739 507	DN11-DS11-DSC11 OIL PAN GASKET	149
371 505	739 505	DS14-DSC14 OIL PAN GASKET	149
371 507	739 503	DS11-DSC11 GASKET	156
371 510	739 590	DS 14 INTAKE MANIFOLD GASKET	153
373 472	737 638	DS11-DSC11 CYLINDER HEAD GASKET	147
378 264	732 846	DS11-DSC11 EXHAUST MANIFOLD GASKET	154
378 299	732 811	DS9 VALVE COVER GASKET	151
387 775	723 335	DS14 GASKET	162
388 422	722 688	GASKET	158
550 469	550 641	DC16 HEAD SET GASKET	146
551 350	559 750	DSC 12.01-02 HEAD SET GASKET	146
551 351	559 759	DSC12 OIL PAN GASKET	149
551 356	559 754	DSC12 FULL SET GASKET	143
551 363	559 747	DSC12 HEAD SET GASKET	145
551 386	559 724	DSC12 124 LGC FULL SET GASKET	144
551 387	559 723	DC16 FULL SET GASKET	144
551 415	559 695	DS8 HEAD SET GASKET	145
551 446	559 664	DS8 OIL PAN GASKET	149
551 449	559 661	DS9-DN9 FULL SET GASKET	143
551 469	559 641	DS14 HEAD SET GASKET	146
551 470	559 630	DS14 - DSC14 FULL SET GASKET	144
551 489	559 621	DS9 - DSC9 HEAD SET GASKET	145
551 512	559 598	DSC11 HEAD SET GASKET	145
551 513	559 597	DS11 HEAD SET GASKET	145
551 516	559 594	DS11 FULL SET GASKET	143
551 519	559 591	DSC11 FULL SET GASKET	143
551 560	559 540	DC9 - DSC- FULL SET GASKET	144
		DS11 TURBO GASKET	155
		WATER PUMP GASKET	160



www.eurogasket.com.tr

INDEX PAGE

To Fit
VOLVO

OEM Part Number	Eurogasket Part Number	Description	Page Number
1 543 581	9 567 529	TD162-163 VALVE COVER GASKET	182
1 543 599	9 567 511	TD162-163 OIL PAN GASKET	181
1 547 562	9 563 548	D12 A-B 12A / FH12A OIL PAN GASKET	181
1 556 387	9 554 723	D16 OIL PAN GASKET	181
1 577 594	9 533 516	D12A / FH12 VALVE COVER SET	185
1 677 656	9 433 454	D12A/B/C/D CYLINDER BLOCK GASKET	195
119 90 107	991 10 903	4300-4300B-4400-4500 / HT100-120 GEAR SET	198
119 900 95-9	991 100 15-1	L90/L90CB/L120/HT 130-131-132 GEAR SET	198
154 385-8	956 725-2	TD162F-FL / D16A / FH16 EXHAUST MANIFOLD GASKET	187
191 179-1	919 931-9	F10 / F12 / FH12 GASKET	195
2 0532 272	8 0578 838	D12 TURBO C GASKET RUBBER	195
2 054 1940	8 056 9160	D13A/B OIL PAN GASKET	181
2 081 2484	8 029 8626	D9A OIL PAN GASKET	181
2 097 9871	8 013 1239	D13A/B CYLINDER BLOCK GASKET	195
20 463 858	80 647 252	D12C INTAKE MANIFOLD GASKET	186
20 532 891	80 578 219	D13-16 / FH12-16 / FM12 GASKET CRANKCASE VENTILATION	195
20 538 793	80 572 317	D13A/B VALVE COVER SET	185
20 777 888	80 333 222	D13 / FH13 / FM13 GASKET CRANKCASE VENTILATION	195
20 805 850	80 205 250	D13A/B INTAKE MANIFOLD GASKET	186
205 43071	805 67039	D13 EXHAUST MANIFOLD GASKET	188
205 55 359	805 55 751	FH12 GASKET	194
207 10242	803 90868	D12C HEAD SET GASKET	176
207 44 865	803 66 245	D16 EXHAUST MANIFOLD GASKET	187
207 81146	803 29964	D9-11-13 TURBO GASKET	192
207 84537	803 26573	D9A / D12-C-D / D16C TURBO GASKET - NEW VERSION	192
208 41816	802 69294	D13A TURBO GASKET	192
208 50815	802 50295	D13A TURBO GASKET	192
240 017-4	860 093-6	FH12C OIL PAN GASKET	180
270 758-6	830 352-4	TD100A-101A-120A / FH12 TURBO GASKET	192
270 761	830 349	D70 A-B / TD70 VALVE COVER SET	183
270 761-0	830 349-0	TD70 VALVE COVER GASKET	182
270 761-0 F	830 349-0 F	TD70 FULL SET GASKET	168
270 762	830 348	TD60B / TD60C VALVE COVER SET	183
270 762-8	830 348-2	TD61 VALVE COVER GASKET	182
270 764	830 346	TD61 F-FB / TD63 / D6A EXHAUST GASKET SET	189
270 765	830 345	TD71 F-FA / TD71 FD EXHAUST GASKET SET	190
270 766	830 344	D50A-B / TD50A-B EXHAUST GASKET SET	189
270 767	830 343	TD100A/B/BG TURBO GASKET SET	192
270 768	830 342	TD60A / TD60B-C EXHAUST GASKET SET	189
270 769	830 341	D60A / TD60A EXHAUST GASKET SET	189
270 770	830 330	D50A / D60A VALVE COVER SET	183
270 770-1	830 330-9	TD60 VALVE COVER GASKET	182
270 771	830 339	D70 A-B / TD70A / TD70C EXHAUST GASKET SET	189
270 772	830 338	TD120-121-122-123 EXHAUST GASKET SET	190
270 774	830 336	TD 61 F-FB CONVERSION SET	170
270 775	830 335	TD 71 F-FA CONVERSION SET	170
270 778	830 332	TD60 B-C CONVERSION SET	170
270 779	830 331	TD50-60 CONVERSION SET	170
270 779-2 F	830 331-8 F	TD50-60 FULL SET GASKET	168
270 779-2 H	830 331-8 H	TD50-60 HEAD SET GASKET	174
270 789-1	830 321-9	TD101-102-103 CYLINDER HEAD GASKET	178
270 789-1 F	830 321-9 F	TD101-102-103 FULL SET GASKET	169
270 789-1 H	830 321-9 H	TD101-102-103 HEAD SET GASKET	175
270 949-1	830 161-9	TD121-122-123 CYLINDER HEAD GASKET	178
270 949-1 H	830 161-9 H	TD 122-123 HEAD SET GASKET	175
270 950-9	830 150-1	TD121 FK / TD122F RUBBER KIT	201



www.eurogasket.com.tr

INDEX PAGE

To Fit
VOLVO

OEM Part Number	Eurogasket Part Number	Description	Page Number
270 950-9	830 150-1	D16A / TD162F RUBBER KIT	201
270 957	830 153	TD 70 A-B CONVERSION SET	170
270 958	830 152	D100 A-B / THD100 A-D EXHAUST GASKET SET	190
270 958-2 H	830 152-8 H	TD100 HEAD SET GASKET	174
270 997	830 113	TD100A/B TURBO GASKET SET	192
271 088	839 022	TD162 F-FS / TD163 FL / FH16 EXHAUST GASKET SET	190
271 090	839 010	TD 162F-FS CONVERSION SET	172
271 155-4	839 955-6	TD121F / TD121 RUBBER KIR	200
271 156-2	839 954-8	TD120C-D-E-F RUBBER KIT	200
271 157-0	839 953-0	THD101 / TD103 / TD101F RUBBER KIT	200
271 160-4	839 940-6	D70A-B / TD70 RUBBER KIT	200
271 160-4	839 940-6	TD71-73 RUBBER KIT	200
271 161-2	839 949-8	RUBBER KIT	200
271 162-0	839 948-0	D60A / TD60A / TD60B / TD60C RUBBER KIT	200
271 181-0	839 929-0	TD120A RUBBER KIT	200
271 558-8	839 952-2	D100A-B / THD100A / TD 101F RUBBER KIT	200
275 460-4	835 640-6	D50A/TD50A/TD50B RUBBER KIT	200
275 525-4	835 585-6	TD70 CYLINDER HEAD GASKET	177
275 525-4 H	835 585-6 H	TD70 HEAD SET GASKET	174
275 548-6	835 562-4	TD120 CYLINDER HEAD GASKET	178
275 548-6 F	835 562-4 F	TD120 FULL SET GASKET	169
275 548-6 H	835 562-4 H	TD 120 HEAD SET GASKET	175
275 551-0	835 559-0	TD100 CYLINDER HEAD GASKET	178
275 551-0 F	835 559-0 F	TD 100 FULL SET GASKET	168
275 553	835 557	HD100A / THD100A/DA VALVE COVER SET	184
275 554	835 556	TD120-121 / TD122-123 VALVE COVER SET	184
275 554-4 F	835 556-6 F	TD121-122-123 FULL SET GASKET	169
275 740-9	835 360-1	TD50-60 CYLINDER HEAD GASKET	177
275 741	835 369	THD100D-DB / THD101-102-103 / DH10A VALVE COVER SET	184
275 774-8 H	835 336-2 H	TD61 HEAD SET GASKET	174
275 776	835 334	TD61 F-FB VALVE COVER SET	183
275 779-7 H	835 331-3 H	TD71 HEAD SET GASKET	174
275 781	835 329	TD71 F-FA VALVE COVER SET	183
275 781-1	835 329-9	TD71 VALVE COVER GASKET	182
275 785	835 325	THD 101 CONVERSION SET	171
276 034	834 076	D100 A-B / TD100 B VALVE COVER SET	184
276 035	834 075	TD100 G-GA / TD101 / TD102-103 VALVE COVER SET	184
276 052	834 058	TD100 G-GA / THD100 EA / TD101-102-103 EXHAUST GASKET SET	190
276 122	834 988	TD 100 A-B CONVERSION SET	171
276 123	834 987	TD 101 F-FA CONVERSION SET	171
276 124	834 986	TD 120-121 CONVERSION SET	171
276 125	834 985	TD 122 CONVERSION SET	171
276 638	834 472	TD162-163 HEAD SET GASKET	175
276 638	834 472	TD162F / TD163ES / D16A / FH16 VALVE COVER SET	185
276 640	834 460	D16A / FH16 TURBO GASKET SET	193
276 807	834 203	D12A TURBO GASKET SET	193
276 815	834 295	TD100-101 TURBO GASKET SET	192
276 816 F	834 294 F	TD71 FULL SET GASKET	168
276 816-6	834 294-4	TD71 CYLINDER HEAD GASKET	177
276 821 F	834 289 F	TD61 FULL SET GASKET	168
276 821-6	834 289-4	TD61 CYLINDER HEAD GASKET	177
276 875	834 235	FH12 HEAD SET GASKET	175
276 888	834 222	D12 A/B CONVERSION SET	172
276 924	834 186	FH16 CYLINDER HEAD GASKET	179
276 930	834 170	FH12 EXHAUST GASKET SET	191
3 093 503	7 017 507	FH12 CYLINDER HEAD GASKET - OLD MODEL	179



www.eurogasket.com.tr

INDEX PAGE

To Fit
VOLVO

OEM Part Number	Eurogasket Part Number	Description	Page Number
3 099 100	7 011 900	FH12 CYLINDER HEAD GASKET - NEW MODEL	179
402 185-3	608 925-7	TD100 INTAKE MANIFOLD GASKET	186
420 160	680 940	TD61-71 GASKET	194
420 220	680 880	TD100-101-102 GASKET	194
420 223	680 887	FH12 / TD61-70-71 GASKET	194
420 226	680 884	TD101-120-121-122 GASKET	194
420 538-1	680 572-9	TD61 EXHAUST MANIFOLD GASKET	187
420 643	680 467	TURBO GASKET - ALL MODELS	192
420 708-0	680 302-0	TD50-60 EXHAUST MANIFOLD GASKET	187
421 131-4	689 979-6	TD50-60-70 SEAL	196
421 147-0	689 963-0	TD50-60-70 SEAL	196
421 534-9	689 576-1	TD70 EXHAUST MANIFOLD GASKET	187
422 283	688 827	TD100-101-120-121-122 GASKET	194
422 418	688 692	TD100-101-102-120-121-122 GASKET RUBBER	196
422 619-7	688 491-3	D100/TD100-101-102-103/THD101-102-103-104 SHIM 0,20mm	199
422 620-5	688 480-5	D100/TD100-101-102-103/THD101-102-103-104 SHIM 0,30mm	199
422 621-3	688 489-7	D100/TD100-101-102-103/THD101-102-103-104 SHIM 0,50mm	199
423 145-2	687 965-8	TD100 VALVE COVER GASKET	182
423 146-2	687 964-8	TD100 VALVE COVER GASKET	182
423 174-2	687 936-8	TD120-121-122 INTAKE MANIFOLD GASKET	186
423 277	687 833	TD120-121-122 GASKET	194
424 600	686 400-5	TD60-61 / D50A OIL PAN GASKET	180
424 602	686 408-9	TD100-101-102 OIL PAN GASKET	180
424 610-4	686 490-6	TD50-60 INTAKE MANIFOLD GASKET	186
424 611	686 499	TD70 INTAKE MANIFOLD GASKET	186
424 618-7	686 492-3	TD120-121-122 GASKET	194
424 634-4	686 476-6	TD100 EXHAUST MANIFOLD GASKET	187
424 692-2	686 418-8	TD120-121-122 VALVE COVER GASKET	182
424 693-0	686 417-0	TD101 VALVE COVER GASKET	182
424 694-8	686 416-2	TD101 VALVE COVER GASKET	182
424 919	686 191	TD70-71 / D70 OIL PAN GASKET	180
465 119-6	645 991-4	TD60A-B TURBO GASKET METAL	193
465 394-5	645 716-5	D60 / TD60-61-63 SHIM 0,20mm	199
465 395-2	645 715-8	D60 / TD60-61-63 SHIM 0,30mm	199
465 396-0	645 714-0	D60 / TD60-61-63 SHIM 0,50mm	199
465 786	645 324	FH12 / TD60-61-70-71 GASKET	194
466 114-6	644 996-4	D70 / TD70-71-73 SHIM 0,20mm	199
466 183-1	644 927-9	D70 / TD70-71-73 SHIM 0,30mm	199
466 184-9	644 926-1	D70 / TD70-71-73 SHIM 0,50mm	199
468 271-2	642 839-8	TD120-121-122-123 SHIM SHIM 0,20mm	199
468 272-0	642 838-0	TD120-121-122-123 SHIM SHIM 0,30mm	199
468 273-8	642 837-2	TD120-121-122-123 SHIM SHIM 0,50mm	199
469 120	641 980	TD60-70-100 GASKET RUBBER	196
469 121	641 989	TD120-121-122 GASKET RUBBER	196
469 122	641 988	TD50-60-61-70-71-72-73-100-101-102-103-120-121-122 GASKET RUBBER	196
469 662	641 448	TRIBUNE INLET GASKET	197
469 823	641 287	TD100-103-120-122 CYLINDER BLOCK GASKET	195
469 823-9	641 287-1	TD100-101-102-120-121-122 GASKET	194
469 829-6	641 281-4	TD101 INTAKE MANIFOLD GASKET	186
470 534-9	630 576-1	TD120-121-122-123 EXHAUST MANIFOLD GASKET	187
470 939	630 171	D9A / D12C-D / D16C TURBO GASKET	192
471 650-2	639 450-8	TD71 EXHAUST MANIFOLD GASKET	187
478 505-1	632 505-9	TD120-121-122-123 OIL PAN GASKET	180
479 107-5	631 903-5	TD101-102 EXHAUST MANIFOLD GASKET	187
575 525-9	535 585-1	F10 / F12 GASKET	195
8 148 049	2 962 061	D9A/B VALVE COVER SET	185



www.eurogasket.com.tr

INDEX PAGE

To Fit
VOLVO

OEM Part Number	Eurogasket Part Number	Description	Page Number
8 149 301	2 961 709	FH12 COOLING FLANGE GASKET	196
8 170 116	2 930 994	D12C / D121D VALVE COVER SET	185
8 170 514	2 930 596	FH12 GASKET	196
8 170 515	2 930 595	FH12 COOLING FLANGE GASKET	195
8 170 519	2 930 591	FH12 THERMOSTAT GASKET	195
8 170 959	2 930 151	FH12 / D12A EXHAUST MANIFOLD GASKET	187
814 8172	296 2938	D9 EXHAUST MANIFOLD GASKET	188
851 03633	259 07477	D12C CONVERSION SET	172
CS 200	29828	TD100 GASKET SET	172
CS 201	26561	TD101-102 GASKET SET	172
CS 202	28851	TD120-121-122 GASKET SET	173
		TD61-71 / FH12 GASKET RUBBER	196
		TD61-71 / FH12 GASKET RUBBER	196



www.eurogasket.com.tr

INDEX PAGE

To Fit
ZF

OEM Part Number	Eurogasket Part Number	Description	Page Number
		GEAR BOX GASKET	206
0501 321 065	0509 789 045	GEAR BOX GASKET - METAL	206
0501 317 289	0509 793 821	GEAR BOX GASKET - METAL	206
6085 298 013	4025 812 097	GEAR BOX GASKET SET	206
0501 322 828	0509 788 282	GEAR BOX GASKET	206
0501 322 829	0509 788 281	GEAR BOX GASKET	207
129 030 1140	981 040 9960	GEAR BOX GASKET	207
132 4307 082	978 6703 028	GEAR BOX GASKET	207
0501 224 626	0509 886 484	GEAR BOX GASKET	207
1268 307 170	9842 703 930	GEAR BOX GASKET	207
1315 298 001	9795 812 009	GEAR BOX GASKET SET	208



www.eurogasket.com.tr

INDEX PAGE

COMPRESSOR GASKET

Vehicle	Compressor OEM No or Gasket OEM No	Eurogasket OEM No	Description	Page Number
DAF	1 320 400	907 5004 900	DB250 / F2100 REPAIR KIT	209
DAF	1 505 917	907 5005 900	REPAIR KIT FULL	210
DAF	1 287 663	907 5006 900	SB 3000 / SBG 220 REPAIR KIT FULL	211
DAF	1 506 365	907 5007 900	2800-3300-3600 REPAIR KIT FULL	212
DAF	1 282 723	907 5008 900	865 AVM - 1160 AVM REPAIR KIT FULL	213
DAF	1 737 654	907 5009 900	85 CF - 75 CF REPAIR KIT FULL	214
DAF	1 331 146	907 5000 800	95XF / CF75 / CF8 / F75 / F95 REPAIR KIT	215
IVECO	984 65003 485 0697	991 5000 900	TURBOCITY / EUROARGO REPAIR KIT	216
IVECO	412 112 129	991 5009 800	EUROTECH / EUROSTAR / STARLIS REPAIR KIT	216
IVECO	931 6153	991 5008 010	TURBOSTAR REPAIR KIT	216
IVECO	79 073 083	991 5007 800	175 / 190 / 240 / 260 REPAIR KIT	216
IVECO	76 623 201	991 5006 800	697 / 619 / 684 REPAIR KIT	216
IVECO	48 605 65	991 5005 900	EUROARGO / MP190 / MP260 REPAIR KIT	217
IVECO	489 7301	991 5004 900	TECTOR REPAIR KIT	217
IVECO		991 5003 900	TECTOR REPAIR KIT	217
IVECO	412 111 22	991 5001 900	STARLIS / TRAKER REPAIR KIT	217
IVECO	504 022 988	991 5090 900	STARLIS / TRAKER REPAIR KIT	217
IVECO	984 65 003	991 5099 900	TURBOCITY / EUROTECH REPAIR KIT	218
MAN	51 54100 7096	031 5007 800	LP 3986 - TGA 41.430 / 41.460 / 41.400 REPAIR KIT	219
MAN	51 54100 6049	031 5008 900	LK 8901 - TG-A REPAIR KIT FULL	220
MAN	51 54114 6049	59 56996 4061	LK 8901-LP 3980-LP 3986-LP 3997 REPAIR KIT FULL TG-A	221
MAN	51 54100 7116	031 5000 800	D2066 LF01-04 DF2676 LOH01 REPAIR KIT	222
MAN	51 54114 6065	032 5000 800	G2866UH-UM / D2866 LUH23 / 19.464 REPAIR KIT	223
MAN	51 54100 6007	033 5000 800	D2866 TUH - D2876 LF01 REPAIR KIT TG-A	224
MAN	51 54100 7069	034 5098 900	LK4908-LK4911 / NU BUS / NM BUS / NL BUS REPAIR KIT FULL	225
MAN	51 54100 6042	034 5099 800	TG-L REPAIR KIT	226
MAN	51 54100 7005	034 5090 800	D0836 LF01-06 / D0834 LF01 / D0834 LOH01 REPAIR KIT	227
MAN	51 54100 6043	034 5000 900	D0826 LOH / D0826 LFL03 / D0826 LF15 REPAIR KIT FULL	228
MAN	51 54101 7210	035 5000 800	D0826 TE520 / D0826 LE 521 REPAIR KIT	230
MAN	51 54101 7204	036 5009 800	D0826F / D2865 LF / D0824 LFL01 REPAIR KIT	231
MAN	51 54101 7150	036 5000 800	LK 3805 / I83460 REPAIR KIT	232
MAN	51 54000 7064	037 5090 800	D2866 TUH / G2866 UH / E2866 DUH01 REPAIR KIT	233
MAN	51 54101 7168	037 5009 800	D0224 MF / D0224 DMF / D0224 MFO REPAIR KIT	234
MAN	81 54111 0026	037 5000 800	D0826F / D0824 LFL01 REPAIR KIT	235
MAN	51 54101 7192	039 5000 800	D0826F / D0826 LOH / D0826 FO REPAIR KIT	236
MAN		044 5000 800	LK1802/LK1814 - 19.190 REPAIR KIT	237
MAN	51 54901 0051	59 56109 0059	D2566 / D2866 COMPRESSOR GASKET	238
MAN	51 54901 0052	59 56109 0059	D2566 / D2866 COMPRESSOR GASKET	238
MERCEDES	906 130 0915	014 5009 900	CITARO OM 906 REPAIR KIT FULL	239
MERCEDES	906 130 1015	014 5000 900	AXOR OM 457 EURO III REPAIR KIT FULL	240
MERCEDES	457 130 3615	016 5075 900	AXOR / TRAVEGO OM 457 EURO IV REPAIR KIT FULL	241
MERCEDES	906 130 1515	016 5070 900	CITARO OM 906 REPAIR KIT FULL	242
MERCEDES	457 130 2715	016 5080 900	AXOR OM 457LA / OM 460LA / M447 HLAG REPAIR KIT FULL	243
MERCEDES	457 130 0815	016 5090 900	AXOR/ATEGO/TRAVEGO OM457LA REPAIR KIT FULL	244
MERCEDES	906 130 0615	016 5008 900	AXOR REPAIR KIT FULL	245
MERCEDES	906 130 2915	016 5009 800	AXOR / ATEGO / CITARO REPAIR KIT	246
MERCEDES	906 130 2915	016 5000 800	AXOR / ATEGO / OM 904-906 REPAIR KIT	247
MERCEDES	442 130 3219	010 5000 900	O304 / O403 / 3031 OM 442-443-447 REPAIR KIT FULL	248
MERCEDES		023 5089 800	EVO BUS OM 401-403-421 REPAIR KIT	249
MERCEDES	407 130 0519	023 5080 800	EVO BUS OM 401-403-421 REPAIR KIT	250
MERCEDES		023 5099 900	OM 401-403-421 REPAIR KIT FULL	251
MERCEDES	000 130 2419	023 5090 900	OM 401-403-421 REPAIR KIT FULL	252
MERCEDES		023 5005 800	UNIMOG OM 364 REPAIR KIT	253
MERCEDES	442 130 0220	023 5006 800	OM 401-403-421 REPAIR KIT	254
MERCEDES	004 131 0101	025 5009 800	OM 355 / LA REPAIR KIT	255
MERCEDES	000 131 4260	025 5000 900	OM 355 REPAIR KIT FULL	256
MERCEDES	541 130 2719	026 5008 900	ACTROS OM 501 LA / OM 502 LA REPAIR KIT FULL	257
MERCEDES		026 5009 900	ACTROS OM 501 LA / OM 502 LA REPAIR KIT FULL	258
MERCEDES	541 131 1219	026 5000 900	ACTROS OM 501 LA / OM 502 LA REPAIR KIT FULL	259
MERCEDES	004 131 9401	029 5800 900	2521 / OM 366 LA REPAIR KIT FULL	260
MERCEDES	004 131 0501	020 5800 900	2517 / OM 366 REPAIR KIT FULL	261
MERCEDES	366 131 0180	744 979 0920	OM 366 COMPRESSOR GASKET 0,90mm	262
MERCEDES	366 131 0180	744 979 0920	OM 366 COMPRESSOR GASKET 0,65mm	262
MERCEDES	442 131 0980	668 979 0120	OM 442 COMPRESSOR GASKET	262
MERCEDES	442 131 0080	668 979 0020	OM 442 COMPRESSOR GASKET	262
MERCEDES	442 131 0780	668 979 0320	OM 442 COMPRESSOR GASKET	262



www.eurogasket.com.tr

INDEX PAGE

COMPRESSOR
GASKET

Vehicle	Compressor OEM No or Gasket OEM No	Eurogasket OEM No	Description	Page Number
MERCEDES	442 131 2480	667 979 8620	OM 442 COMPRESSOR GASKET	263
MERCEDES	000 131 4631	000 979 6479	COMPRESSOR VALVE DISC	263
MERCEDES	000 131 3831	000 979 7279	COMPRESSOR VALVE DISC	263
MERCEDES	541 131 0780	569 979 0320	OM 501-502 COMPRESSOR GASKET - METAL	263
MERCEDES	4900 62	6100 48	OM 355 COMPRESSOR GASKET SET	263
MERCEDES	4900 235	6100 875	COMPRESSOR GASKET SET Ø88	264
RENAULT-RVI	20774360	987 5006 900	PREMIUM 440 REPAIR KIT FULL	265
RENAULT-RVI	5000 694 824	987 5007 010	MAGNUM / KERAX REPAIR KIT FULL	266
RENAULT-RVI	7420 733 886	987 5008 900	MAGNUM DXI REPAIR KIT FULL	267
RENAULT-RVI	5001 859 253	987 5009 900	PREMIUM / KERAX / MAGNUM E-TECH REPAIR KIT FULL	268
RENAULT-RVI	5001 867 708	987 5000 010	PREMIUM / KERAX / MAGNUM REPAIR KIT FULL	269
SCANIA	1 537 794	909 5904 900	N94 / 4 SERIES BUS REPAIR KIT FULL	270
SCANIA	1 396 282	909 5905 900	LP 4920-LP 4970 REPAIR KIT FULL	271
SCANIA	1 796 663	909 5906 900	4 SERIES P,R,T TRUCK / LP 4957-LP 4963 REPAIR KIT FULL	272
SCANIA	3 090 378	909 5907 900	LP 4825-LP 4829 REPAIR KIT FULL	273
SCANIA	1 303 226	909 5908 900	LP 4814-LP 4815-LP 4844 / 3 SERIES-4 SERIES REPAIR KIT FULL	274
SCANIA	1 348 920	909 5909 900	TUFLO 700 / 3 SERIES REPAIR KIT FULL	275
VOLVO	272 813	908 5000 900	FL7 / FL10 / FL12 REPAIR KIT	277
VOLVO	1 080 437	908 5008 010	FL7 / FL10 / FL12 REPAIR KIT	277
VOLVO	1 613 632	908 5005 900	FL16 / FL10 / FL7 B7 REPAIR KIT	277
VOLVO	2 045 1727	908 5001 900	FM9 REPAIR KIT	277
VOLVO	204 23 341	908 5090 800	FL 12 REPAIR KIT	277
VOLVO	1 699 822	908 5099 010	FL 12 REPAIR KIT	278
VOLVO	20569224	908 5098 980	FH12 / FM12 REPAIR KIT	278
VOLVO	4897300	908 5097 900	FL 6 REPAIR KIT	278
VOLVO	3181133	908 5096 800	FL 6 REPAIR KIT	278
VOLVO	20478166	908 5095 900	FM9 / FM12 REPAIR KIT	278
VOLVO	20845313	908 5094 900	FH12 / FH16 REPAIR KIT	279
VOLVO	20770303	908 5093 900	B12 M / B12 B REPAIR KIT	279
VOLVO	20701801	908 5092 900	FM 12 / NH 12 REPAIR KIT	279
VOLVO	20569251	908 5080 900	FH 16 REPAIR KIT	279
VOLVO		908 5089 990	B7 REPAIR KIT	279
VOLVO	3090378	908 5806 900	F10 / F12 / NL10 / NL12 REPAIR KIT	280
VOLVO	162859	908 5804 900	B10 / B12 / FH12 / FH16 REPAIR KIT	280
VOLVO	85104629	908 5803 900	F10 / F12 / FL7 REPAIR KIT	280
VOLVO	3095843	908 5802 900	FM7 / FM12 / B10 REPAIR KIT	280



UCEM OTOMOTİV

E-5 Güzelce Sapağı Fıratpen Caddesi No:35

Türkoba - Büyükçekmece İstanbul - Türkiye

Tel : +90 (212) 859 09 99 Pbx - Fax :+90 (212) 859 11 01

e-mail : mmm@ucmparts.com

web: www.eurogasket.com.tr

UCEM OTOMOTİV

E-5 Güzelce Sapağı Fıratpen Caddesi No:35
Türkoba - Büyükçekmece İstanbul - Türkiye
Tel : +90 (212) 859 09 99 Pbx
Fax :+90 (212) 859 11 01
e-mail : mmm@ucmparts.com

